

The Nature of Individual Differences in Working Memory Capacity: Active Maintenance in Primary Memory and Controlled Search From Secondary Memory

Nash Unsworth and Randall W. Engle
Georgia Institute of Technology

Studies examining individual differences in working memory capacity have suggested that individuals with low working memory capacities demonstrate impaired performance on a variety of attention and memory tasks compared with individuals with high working memory capacities. This working memory limitation can be conceived of as arising from 2 components: a dynamic attention component (primary memory) and a probabilistic cue-dependent search component (secondary memory). This framework is used to examine previous individual differences studies of working memory capacity, and new evidence is examined on the basis of predictions of the framework to performance on immediate free recall. It is suggested that individual differences in working memory capacity are partially due to the ability to maintain information accessible in primary memory and the ability to search for information from secondary memory.

Keywords: working memory capacity, individual differences, active maintenance, controlled search

Researchers have long been interested in the scientific study of memory processes (Ebbinghaus, 1885/1964) as well as individual differences in memory abilities (e.g., Jacobs, 1887; see also Blankenship, 1938). Although these two research areas have flourished over the past 100 years, there have been few attempts to integrate experimental and differential approaches as has been advocated by several researchers in both fields (Cohen, 1994; Cronbach, 1957; Underwood, 1975). One research area that has embraced the combining of what Cronbach (1957) called the “two disciplines of scientific psychology” is that of individual differences in working memory capacity (WMC). In this article, we continue this integrative approach by examining individual differences in WMC in terms of a general framework of memory that combines a flexible attentional component with a cue-dependent search mechanism (e.g., Davelaar, Goshen-Gottstein, Ashkenazi, Haarmann, & Usher, 2005; Raaijmakers & Shiffrin, 1980, 1981). We combine our previous work arguing for a link between active maintenance and WMC (Engle & Kane, 2004) with newer work arguing for a link between controlled cue-dependent search and WMC (Unsworth & Engle, in press). Below, we review the importance of individual differences in WMC and present a general framework within which to interpret individual differences in WMC. Finally, we present evidence from a new experiment supporting such a view.

Nash Unsworth and Randall W. Engle, School of Psychology, Georgia Institute of Technology.

We thank Rich Heitz and Tom Redick for helpful comments in all phases of this research project. We also thank Nelson Cowan, Alice Healy, Janet Metcalfe, and John Wixted for critical readings of the article.

Correspondence concerning this article should be addressed to Nash Unsworth, who is now at the Department of Psychology, University of Georgia, Athens, GA 30602-3013. E-mail: nunswor@uga.edu

Individual Differences in WMC

Given the need to keep information accessible over brief intervals, several memory theorists have given considerable thought to how a system might go about maintaining information and in what tasks such a system would be needed. Atkinson and Shiffrin (1971) and Baddeley and Hitch (1974), among others, argued for a dynamic memory system where the function of immediate memory was to carry out cognitive operations important for a wide variety of tasks. Specifically, Baddeley and Hitch (1974) argued for a memory system that could simultaneously manipulate the current contents of memory as well as update information in memory to accomplish task goals. The functional nature of this system is apparent when one needs to maintain information over the short term in such diverse tasks as reading comprehension and matrix reasoning. Given the need for such a system for higher order cognitive processes like reasoning and reading, researchers began to hypothesize that individual variation in the system should be related to performance on other cognitive tasks.

Beginning with the work of Daneman and Carpenter (1980), researchers have attempted to examine aspects of the working memory model by examining individual differences in working memory and their relation to higher order cognition. Daneman and Carpenter created a complex memory span task known as *reading span* in which participants were required to read a series of sentences and try to remember the last word of each sentence for later recall. Thus, the task required participants to store information (words) over a short time span while at the same time engaging in a processing activity (reading). The idea was that this task measured the working memory system that gives rise to complex behavior better than a simple memory span task in which participants are required to remember items without a secondary processing task (e.g., word span). Daneman and Carpenter showed that the complex reading span task did a better job of predicting

reading comprehension scores than did the simple memory span task. Accordingly, Daneman and Carpenter argued that working memory was a better predictor of complex cognitive activities than simple short-term memory.

Following the lead of Daneman and Carpenter (1980), additional work has shown that these complex memory span tasks predict performance on a number of higher order cognitive tasks. These included demonstrations that variation in WMC is related to variation in vocabulary learning (Daneman & Green, 1986), computer language learning (Kyllonen & Stephens, 1990; Shute, 1991), as well as performance on standardized aptitude tests such as the Scholastic Aptitude Test (SAT; Turner & Engle, 1989). Furthermore, a large body of literature has been devoted to examining the link between measures of WMC and measures of fluid abilities (Ackerman, Beier, & Boyle, 2002; Conway, Cowan, Bunting, Theriault, & Minkoff, 2002; Engle, Tuholski, Laughlin, & Conway, 1999; Kane et al., 2004; Kyllonen & Christal, 1990; Unsworth & Engle, 2005). Each of these studies has shown that variation in WMC is important in a host of higher order cognitive tasks.

The Working Memory Problem

Although the previous review suggests that WMC is important in a number of domains, working memory as a system is not needed in all cognitive operations. For instance, many cognitive operations that people engage in on a daily basis can be carried out in a fairly automatic fashion with little or no reliance on a working memory system (e.g., James, 1890; Posner & Snyder, 1975; Schneider & Shiffrin, 1977). Take, for instance, the simple example of driving to work. Chances are that one generally takes the same route nearly every day to work. After many days, weeks, months, and even years, driving to work becomes fairly automatized. One does not need to think about what lane to get in or where to turn and so forth. These basic routines can be retrieved almost effortlessly from memory and allow one to talk on a cell phone, fiddle with the radio, or adjust the levels of heat while driving. A general working memory system is needed, however, when current task goals conflict with these automatic tendencies. For example, assume that today one is supposed to drive to the dentist office before going to work. In such a case, it is critically important to keep the task goal actively maintained in order to override the automatic response of driving to work. If one loses maintenance to the task goal of driving to the dentist while captured by a song on the radio, it is likely that one will find oneself halfway to work.

In a broad sense then, working memory is engaged when control is needed to overcome automatic tendencies. In particular, working memory is needed to maintain new and novel information in a heightened state of activity. This is particularly needed when there is considerable external (e.g., music on the radio, child in the backseat crying, etc.) and internal (e.g., ruminations about a fight with one's spouse last night, what to have for dinner tonight, etc.) distraction and interference.

Additionally, given that it is unlikely that people can maintain a great deal of information indefinitely, working memory will also be needed to retrieve information that could not be maintained. In particular, this information will likely have to be retrieved in the presence of irrelevant information that interferes proactively with the relevant information. For instance, in the above example,

information associated with driving to work is not relevant for driving to the dentist office, but because it usually is relevant, it competes for access with the currently relevant information of driving to the dentist. Thus, what is critical is the ability to correctly discriminate between relevant (e.g., routines associated with driving to the dentist) and irrelevant (e.g., routines associated with driving to work) information in regard to a current task goal. This discrimination process likely relies on contextual cues to determine what is relevant versus irrelevant (e.g., Capaldi & Neath, 1995). On most days, driving to work is the correct response; however, in the current context of needing to drive to the dentist, information associated with driving to work becomes the irrelevant information. Thus, the current context defines what is relevant versus irrelevant. In such a situation, it is critically important that the contextual cues activate only that information that is currently relevant. Any noise in the contextual cues increases the probability that the relevant information is not found and instead irrelevant information is retrieved. Working memory limitations arise, then, from the inability to actively maintain information and the inability to retrieve task relevant information in the presence of highly interfering competitors.

The main points of the above framework can be summarized as follows.

1. Working memory is needed when control is needed to override automatic response tendencies.
2. Working memory fulfills two basic functions, maintenance and retrieval: (a) Maintenance is needed to keep new and novel information in a heightened state of activity, particularly in the presence of internal and external distraction. (b) Because the system is limited by how much information can be maintained at any given time, sometimes retrieval of that information in the presence of irrelevant information is required. To retrieve task relevant information, a discrimination process is needed to differentiate between relevant and irrelevant information on the basis of a combination of cues, particularly context cues.

These interrelated functions of maintenance and retrieval form the core of our framework in terms of understanding the nature of WMC. We argue that individual differences in WMC arise from differences in both the ability to actively maintain information and the ability to retrieve task relevant information in the presence of irrelevant information. Thus, the current view combines more traditional notions of working memory as active maintenance (see, e.g., Miyake & Shah, 1999) with work arguing for the importance of context-based retrieval processes (e.g., Capaldi & Neath, 1995; Raaijmakers & Shiffrin, 1980).

Maintenance in Primary Memory and Retrieval From Secondary Memory

In our view, working memory consists of a subset of activated memory units, some of which are highly active and can be considered to be in a limited capacity short-term component. This conceptualization is similar to classic dual-store models of memory positing a limited capacity component important for maintain-

ing information over short time intervals and a larger more durable component important for maintaining information over longer time intervals (Atkinson & Shiffrin, 1968; Norman, 1968; Raaijmakers & Shiffrin, 1980; Waugh & Norman, 1965). In keeping with the terminology initially used by James (1890), we refer to these two components as primary memory (PM) and secondary memory (SM; cf. Craik, 1971; Craik & Levy, 1976; Waugh & Norman, 1965). Although the conceptualization relies on older theoretical distinctions, the overall framework is based on new instantiations of some of these ideas, including Cowan's (1995) model of the focus of attention, the episodic buffer postulated by Baddeley (2000), as well as Oberauer's (2002) working memory model. However, our view is probably most consistent with the activation buffer in the neurocomputational model advanced by Davelaar, Usher, and colleagues (Davelaar & Usher, 2002; Davelaar et al., 2005; Haarmann & Usher, 2001; Usher & Cohen, 1999).

Primary Memory

In our framework, we consider PM and SM to be qualitatively and functionally distinct. PM serves to maintain a distinct number of separate representations active for ongoing processing by means of the continued allocation of attention. Consistent with prior work, PM is thought to have an upper bound of approximately four items (e.g., Atkinson & Shiffrin, 1968; Broadbent, 1975; Cowan, 2001; Glanzer, 1972). When more than four items are present, items currently within PM are displaced and must be recalled from SM by means of a cue-dependent search process (Shiffrin, 1970). Item representations can be displaced from PM by incoming information, such as new item representations in a long list. In this case, some items are maintained in PM while others are displaced (e.g., Davelaar et al., 2005; Raaijmakers & Shiffrin, 1980). Item representations can also be displaced from PM through the disengagement of attention from the maintained items, for example, when performing a distracting secondary task. In this case, all items are displaced from PM because of the removal of attention.

Similar to the activation buffer model proposed by Davelaar et al. (2005), the capacity limit is due to the fact that only about four items can be distinctly maintained (see Usher, Cohen, Haarmann, & Horn, 2001, for a discussion). As argued by Davelaar et al. (2005) and Cowan (2004), this view suggests that PM is not simply a buffer limited to four slots, but rather is a more dynamic system that can change because of task demands (see also Atkinson & Shiffrin, 1968). For instance, in some situations it is optimal for PM to be restricted to only one item or goal representation. This may occur when trying to maintain only one representation, such as a goal state, in the presence of distracting or interfering information (see Heitz & Engle, in press; Usher & Cohen, 1999). In most list memory tasks, such as immediate serial and free recall, however, it is optimal to keep the size of PM at its maximum to maintain as many distinct items as possible. This is because at recall, items that are in PM are simply unloaded and recall is nearly perfect. Furthermore, maintaining items in PM selectively protects those items from proactive interference (PI; Cowan, Johnson, & Saults, 2005; Craik & Birtwistle, 1971; Davelaar et al., 2005; Halford, Mayberry, & Bain, 1988; Wickens, Moody, & Dow, 1981).

Secondary Memory

Items that have been displaced from PM must be retrieved from SM. Consistent with other models, we assume that retrieval from SM requires a cue-dependent search process (e.g., Shiffrin, 1970; Shiffrin & Atkinson, 1969). Because retrieval from SM is a competitive process, one key to successful retrieval is the ability to effectively delimit the search process to only relevant information through the use of different cues (e.g., temporal, contextual, categorical, etc.). After the search set has been delimited, representations are then sampled and retrieved from the search set. Retrieval from SM is fraught with potential problems, such as PI, encoding deficiencies, and output interference. For instance, as PI builds, the search set gets progressively larger, thus leading to inefficient retrieval (O. C. Watkins & Watkins, 1975; Wixted & Rohrer, 1993). Thus, depending on the given task situation, some cues may be more appropriate than others. In an episodic memory task where one is required to remember a list of unrelated words, temporal-contextual cues are likely to be the most optimal cues to use. To recall a high proportion of information, it is important to correctly discriminate current list items from items appearing in previous lists, as well as to discriminate items within a list.

Consistent with previous research (e.g., G. D. A. Brown, Preece, & Hulme, 2000; Estes, 1955; Glenberg, Bradley, Stevenson, Kraus, & Renzaglia, 1983; Glenberg et al., 1980; Lee & Estes, 1981), we assume that several different contextual elements are associated with each item at encoding and that these different contextual elements change at different rates (e.g., Unsworth & Engle, 2006a). Similar to Glenberg et al. (1980), we assume that the different rates of contextual change come from a continuum, but for simplicity we suggest three main levels of contextual change that form a hierarchy. At the top of the hierarchy are global contextual elements that are associated with features unlikely to change much during the experiment, including the room the experiment is in and the gender of the experimenter. Subsumed under the global level are contextual elements that are associated with each list. Finally, at the lowest level of the hierarchy are rapidly changing contextual elements associated with each to-be-remembered item. During encoding, contextual elements from each level of the hierarchy are associated with each to-be-remembered item. During recall, temporal-contextual cues composed of these contextual elements are used to constrain search, and items are subsequently sampled and recalled from the constrained search set. However, the extent to which the search set is constrained depends on which contextual elements are used as cues. Cues composed of elements from lower in the hierarchy tend to focus the search to a greater extent than cues composed of elements from higher levels in the hierarchy.

Additionally, the effectiveness of the cues used depends on the match between encoding and retrieval contexts (i.e., encoding specificity; Tulving & Thomson, 1973). That is, the effectiveness of the temporal-contextual cues used at recall depends on the similarity of the contextual elements at recall and the contextual elements at encoding. The more dissimilar the two contexts are, the lower the probability of sampling a given item. Hence, items presented close to the recall period are likely to share more contextual elements with those present at the moment of recall than are items presented further back from the recall period, leading to fewer items being in the search set and a higher

subsequent probability of recall (e.g., Glenberg, 1987; Glenberg & Swanson, 1986). Additionally, contextual elements associated with items presented further away from the recall period share more contextual elements with items from previous trials, increasing the probability that previous list items are included in the search set (i.e., intrusions). Thus, it is important to have a fairly focused search so that only a few items are represented in the search set, leading to a high probability of correct recall. Consistent with other views of temporal-contextual retrieval (e.g., G. D. A. Brown et al., 2000; Glenberg et al., 1980, 1983), there are three important assumptions: (a) at encoding, items are associated with various contextual elements that change at different rates, (b) at retrieval, items are sampled on the basis of the match between encoding context and the retrieval context (i.e., encoding specificity) by means of a cue-dependent search process, and (c) the more items that are activated by the same cue, the lower the probability of retrieving any given item (i.e., cue overload; M. J. Watkins, 1979). These three assumptions form the core components for retrieving information from SM.

Individual Differences in WMC as Differences in Maintenance and Retrieval

According to the above framework, individual differences in WMC (as measured primarily by complex span tasks in which to-be-remembered items are interspersed with some form of distracting activity) result from differences in the ability to maintain information in PM and the ability to retrieve information from SM. Specifically, individuals who score low on complex working memory span tasks (low WMC individuals) are poorer at actively maintaining information than are individuals who score high on complex working memory span tasks (high WMC individuals). In situations where new and novel information needs to be maintained to generate the correct response, low WMC individuals are more likely to have their attention captured by distraction and thus are more likely to lose access to the task goal compared with high WMC individuals. Furthermore, in situations where information could not be actively maintained, low WMC individuals are poorer at retrieving the relevant information because of a poorer discrimination process at retrieval. In particular, low WMC individuals are likely to use context cues that activate more irrelevant information than those used by high WMC individuals, which leads to both slower and less accurate recall for low WMC individuals.

Next, we review evidence demonstrating WMC differences in situations where task goals have to be maintained in the presence of strong habitual responses and differences in situations where information has to be retrieved in the presence of interference. In both cases, WMC differences appear only in conditions where active maintenance or controlled retrieval is required. No differences are found in conditions where active maintenance is not required or where information can be automatically retrieved. Finally, we present new evidence demonstrating WMC differences in maintenance and retrieval in the same task.

Individual Differences in WMC and Active Maintenance of Task Goals

At first glance, the view we have espoused here might strike some as being contrary to our earlier views about the role of

attention in WMC (e.g., Engle & Kane, 2004; Unsworth, Schrock, & Engle, 2004). However, the views are actually quite compatible and naturally go together. For instance, consider the PM component. We have argued that the function of PM is to maintain a distinct number of separate representations active for ongoing processing. These representations remain active because attention is being allocated to them. If attention is removed, because new information is intentionally being processed or because attention has been captured by environmental stimuli (e.g., a flashing light), representations are displaced from PM. The idea that attention and the capacity of PM are intimately related is not new. In discussing the nature of PM, Craik and Levy (1976) suggested that “information is ‘in PM’ only by virtue of the continued allocation of attention; when attention is diverted the trace is left in SM” (p. 166). Craik and Levy went on to note that “the capacity of primary memory is the number of events that can be attended to simultaneously or the number of internal representations that can be simultaneously activated by the process of attention” (Craik & Levy, 1976, p. 166). Similar to the view advocated here, Craik and Levy (see also Shiffrin, 1976) argued that the capacity of PM is the capacity to maintain a distinct number of representations by continually paying attention to those representations. Thus, PM is a flexible component that changes because of task demands (see Cowan, 2004; Davelaar et al., 2005, for similar views). In tasks where many representations need to be maintained (e.g., list memory tasks), the capacity of PM is maximal. In other tasks where only a single representation needs to be maintained (e.g., maintaining a goal representation), the capacity of PM shrinks to encapsulate only this one representation (for a time-course analysis of this process applied to individual differences in selective attention, see Heitz & Engle, in press). In both situations, the representations are maintained by continually paying attention to them. If attention is diverted by a distracting external or internal stimulus, the representation or representations are not maintained and performance suffers.

Much of our previous work has been devoted to examining instances where the capacity of PM needs to be reduced to maintain a single representation. This work has examined the importance of goal maintenance in situations where correct responses are pitted against incorrect, highly prepotent responses. For instance, consider the antisaccade task (Hallet, 1978). In this task, participants are required to make a saccade either toward (prosaccade) or away (antisaccade) from a flashing cue. On prosaccade trials, the task goal and the prepotent response coincide (e.g., look at the flashing box). Relying on either goal maintenance or automatic orienting results in the correct behavior. On antisaccade trials, however, the task goal and the prepotent response conflict (e.g., if flashing on the left, look to the right). Hence, on antisaccade trials, it is critically important to maintain the task goal for accurate responding to occur. If the task goal is not actively maintained, any momentary lapse in attention results in attentional capture by the cue (Roberts, Hager, & Heron, 1994; Roberts & Pennington, 1996). In this case, the capacity of PM would be reduced to protect the one goal representation, rather than the many item representations.

We have argued that high and low WMC individuals differ in the extent to which they can maintain representations in PM, including goal representations, and thus low WMC individuals should demonstrate poorer performance on antisaccade trials, which is exactly the case (Kane, Bleckley, Conway, & Engle,

2001; Unsworth et al., 2004). Specifically, in one experiment (Unsworth et al., 2004, Exp. 1), low and high WMC individuals did not differ in the number of errors or the latency of correct saccades in prosaccade blocks. On antisaccade trials, however, low WMC individuals were both slower and more error prone than high WMC individuals. This suggested that the low WMC individuals had problems actively maintaining the task goal and were instead captured by the exogenous cue, resulting in a reflexive saccade. In a second experiment (Unsworth et al., 2004, Exp. 2), we intermixed pro- and antisaccade trials in the same block to put a premium on active maintenance even for prosaccades. That is, when antisaccades or prosaccades are presented in a blocked fashion, the task context indicates what the next trial will be, and thus, there is little need for active maintenance on prosaccade trials. However, if pro- and antisaccade trials are intermixed in the same block of trials, the previous trial no longer predicts what behavior is required on the current trial. Thus, active maintenance of task goals is needed not only on antisaccades, but on prosaccades as well. Accordingly, WMC differences should appear not only on antisaccade trials, as in the first experiment, but on prosaccade trials. This was precisely the case. Low WMC individuals were more error prone than high WMC individuals on both pro- and antisaccade trials, indicating that they were less efficient at actively maintaining the task goal.

This ability to maintain task goals and prevent attentional capture is of critical importance in a number of other paradigms where WMC differences have been found, including Stroop (Kane & Engle, 2003; Long & Prat, 2002) and dichotic listening (Conway, Cowan, & Bunting, 2001). In the Stroop task, the task goal is to indicate the color of ink that a color word appears in. When the color of ink and the word match (e.g., *BLUE* presented in blue ink), habitual word reading and the task goal coincide. However, when the color of ink and the task goal do not match (e.g., *BLUE* presented in red ink), it is critically important to maintain the task goal in order to override the habitual response and give the correct response (e.g., red). Furthermore, in line with the pro- and antisaccade findings, the extent to which goal maintenance is needed varies depending on whether previous trials predict what behavior is required on the current trial. If all of the trials are incongruent (i.e., the color of the ink and the word don't match), there is little need for active maintenance because the previous trial always reinforces the task goal on the current trial (e.g., name the color, not the word). In such a case, WMC differences should not appear. However, when most of the trials are congruent, active goal maintenance is critical for responding correctly on those rare incongruent trials. In such a case, large WMC differences should appear. Relevant data come from a series of studies conducted by Kane and Engle (2003). Kane and Engle found that in a 0% congruent condition, there were virtually no WMC differences in error rates, suggesting that both high and low WMC individuals were able to perform the task accurately. However, in a 75% congruent condition, Kane and Engle found that low WMC individuals made many more word reading errors than high WMC individuals, suggesting that they were more likely to lose the task goal and base their responses on habit.

This review suggests that WMC differences occur only when active maintenance of task goals is needed in the presence of salient distracting information. In conditions where active maintenance is not required for correct responding, WMC differences did

not occur. Thus, it is not the case that WMC is required on all tasks or in all conditions. Rather, WMC is needed in such tasks only when active maintenance of task relevant information is needed to override fairly automatic responses.

Individual Differences in WMC and Controlled/Strategic Search

When active maintenance of information is impeded, task relevant information needs to be retrieved from SM in the presence of competition. In these cases, a controlled/strategic search of SM must be undertaken to retrieve the correct information. This search process relies on cues to discriminate what is relevant versus irrelevant to reduce the amount of competition at retrieval (Capaldi & Neath, 1995). In such situations, low WMC individuals are more affected by PI because of an inability to use cues to guide the search process. That is, low WMC individuals are poorer at discriminating between relevant and irrelevant information and include many irrelevant representations in their search sets. To better examine this hypothesis, we rely on a random search model (Bousfield, Sedgewick, & Cohen, 1954; Kaplan, Carvellas, & Metlay, 1969; McGill, 1963; Rohrer & Wixted, 1994; Wixted & Rohrer, 1994). Here we briefly describe the random search model and apply it to individual differences in WMC and retrieval.

The retrieval scheme for the search process is shown in Figure 1. In the random search model, a retrieval cue (i.e., a context cue) first delimits a search set that includes representations for target items as well as extraneous items. The search set is delimited by cues generated by the participant and possibly by external cues presented during the retrieval period (i.e., cued recall, recognition, etc.). As with other search models, we assume that participants always use internally generated context cues to attempt to focus the search on only the relevant representations (e.g., Raaijmakers & Shiffrin, 1980). Furthermore, as with the PM component, attention is needed here as well to decide how to search, to determine what cues should be used for the search, and to determine how the cues should be combined for search.

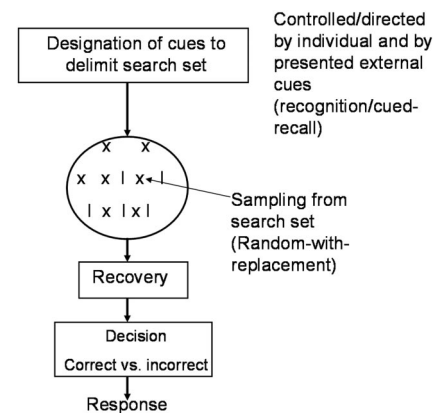

Figure 1. Schematic of retrieval from secondary memory. Individuals first designate cues to delimit the search set. Targets (Xs) and intrusions (Is) are then sampled from the search set. If there is enough information, the items are recovered and subjected to a decision process that decides if the recovered representation is a target or an intrusion.

Once the search set has been delimited, item representations are randomly sampled from the search set at a constant rate, one item at a time (serial search). The sampling process is assumed to occur with replacement, such that after a target item has been sampled and recalled, it still has an equal chance of being selected on the next sample. Like other search models, the random search model assumes that an item's strength relative to all other items in the search set determines its probability of being sampled (e.g., Shiffrin, 1970). Clearly, within this framework stronger items have a greater probability of being sampled and recalled than weaker items. However, the random search model assumes, for simplicity, that all items are of equal strength (e.g., Rohrer, 1996). Thus, all items comprising the search set have an equally likely chance of being sampled. Within this model, the search set is composed of target items that have not been recalled, target items that have been previously recalled, items from previous lists, as well as extralist items.

During the recall period, the probability of recalling any new target item should decrease because each sample is likely to be an already recalled target item or an extraneous item. Using the terminology of Wixted and Rohrer (1994), assume that there are N recoverable targets within a search set of size S , which includes both target and nontarget representations as discussed earlier. On the first sample from the search set, the probability of selecting a target that is recoverable is as follows:

$$N/S. \quad (1)$$

During subsequent samples, the probability of finding a new recoverable target representation is affected by the number of representations that have already been recalled. Thus, the probability of sampling a new target is as follows:

$$(N - R)/S, \quad (2)$$

where, here, R represents the number of previously recovered target representations (Wixted & Rohrer, 1994). Thus, as R increases, the probability of sampling a new target representation decreases. According to the current framework, low and high WMC individuals have the same values for N , but low WMC individuals have larger values of S . This is because

$$S = N + PLI + ELI, \quad (3)$$

where PLI represents the number of interfering item representations from previous trials, and ELI represents the number of extraneous interfering representations that may be semantically or phonologically associated with some of the target representations. Thus, low WMC individuals have larger values of PLI (and perhaps ELI) than high WMC individuals.

After an item has been sampled, it must be recovered into consciousness to be recalled (Raaijmakers & Shiffrin, 1980). Only those items that exceed some absolute threshold are actually recovered and subjected to a decision/monitoring process. The decision/monitoring process must determine whether the recovered item is a target representation and then recalled or is a nontarget representation and not recalled. In terms of individual differences in WMC, we assume in this article that individuals differ only in the ability to use cues to delimit the search set and not in either the recovery process or the decision/monitoring process. That is, we assume that high and low WMC individuals do not differ in the

number of recoverable targets within their search sets or in the efficiency of their decision/monitoring process in catching nontargets from being recalled. In reality these assumptions are not likely to hold in some cases, but for simplicity we assume that they do. Using this framework as the basis for our SM search mechanism, it is possible to interpret a number of findings concerning WMC differences in retrieval.

Recall Tasks

Tasks that require recall of items in lists in the absence of any external cue require that internally generated context cues be used to search SM for target items. As noted previously, at encoding each item is associated with several different contextual states. At recall, these contextual states are used to delimit a search set in SM from which items are sampled. Assuming that low WMC individuals' cues are associated with more items from previous trials than are those of high WMC individuals, then the probability that low WMC individuals will sample target items is lower than the probability for high WMC individuals. Shown in Figure 2 is a depiction of low WMC individuals' recall deficits based on the notion that their search sets contain more *PLIs* compared with those of high WMC individuals. This simple notion of low WMC individuals having more intruding representations in their search sets can explain a number of findings concerning individual differences in WMC and recall. Specifically, in recall tasks low WMC individuals should recall fewer items (as is typically the case), emit more intrusions (particularly previous list intrusions), and be slower to recall items than high WMC individuals.

In previous work, we have relied on some of these notions to examine performance on the complex span tasks that are used to categorize high versus low WMC individuals (Unsworth & Engle, 2006a, 2006b). Specifically, we have argued that maintenance of information in PM and retrieval from SM are important in the complex span tasks (Unsworth & Engle, 2006a), and that retrieval from SM likely requires the use of temporal-contextual cues to access items (Unsworth & Engle, 2006b). We do not reiterate those findings here, but rather demonstrate how differences in

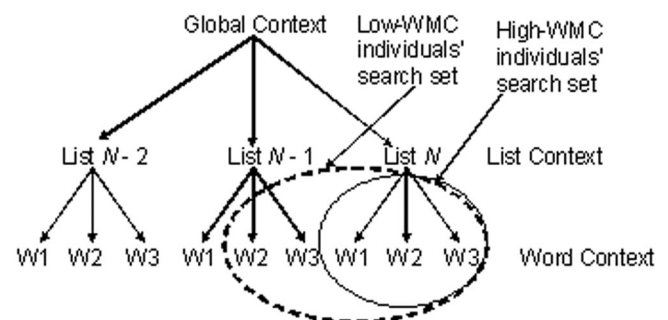

Figure 2. Depiction of high and low WMC individuals' search sets on the basis of contextual cues used at retrieval. Individuals rely on the current contextual state to retrieve items from the current list (List N). However, noisy list context cues tend to activate items from the immediately preceding list (List $N - 1$), leading to the inclusion of interfering item representations from previous trials in the search set. WMC = working memory capacity; W = word.

search set size can account for performance differences in the complex span tasks.

For instance, within the current framework, consider why it is that low WMC individuals recall fewer items than high WMC individuals in the complex span tasks. As noted previously, in complex memory span tasks, such as operation (Turner & Engle, 1989) and reading span (Daneman & Carpenter, 1980), to-be-remembered items are interspersed with some form of distracting activity, such as solving math operations or reading sentences. For example, a list length of three in the operation span might be as follows:

IS (8/2) – 1 = 1? Bear

IS (6 × 1) + 2 = 8? Drill

IS (10 × 2) – 5 = 15? Job

???

Participants are instructed to solve the math operations and remember the words. At the recall signal (???), participants are required to recall the words in the order of presentation. As with the continuous distractor paradigm (Bjork & Whitten, 1974), items are presented and held within PM, but are quickly displaced because of the need to switch attention to the processing of the operations.¹ Thus, these items are (generally) recalled from SM. At retrieval, contextual cues are used to delimit the search set to the current items. However, as with other recall tasks, the internally generated context cues are likely to activate items from previous trials because of overlap in contextual states. This causes the size of the overall search set (*S*) to be increased, leading to a lower probability of sampling target items and an increased probability of sampling intrusions. Thus, this view suggests that PI builds in complex span tasks because the context cues used to delimit the search set to current items also activate items from previous trials.

Several studies have suggested that PI builds in the complex span tasks, which leads to performance deficits (e.g., Bowles & Salthouse, 2003; Bunting, 2006; May, Hasher, & Kane, 1999). In most of these studies, the ability to detect clear support for PI has been hampered by the fact that list length has typically been manipulated as well. However, Bunting (2006) used only list lengths of six and found clear evidence not only of PI buildup in a version of operation span, but also of PI release effects. Specifically, Bunting presented participants with trials composed of either words or digits. Using the same stimuli across successive trials (i.e., words on Trials 1 and 2), Bunting found typical PI effects where performance on Trial 2 was poorer than on Trial 1. On Trial 3, Bunting switched the type of memoranda (i.e., words to digits) and found clear PI release effects where performance on Trial 3 was actually better than on Trial 1. Further support for PI as a factor in complex spans comes from error analyses that show that intrusion errors are typically items that come from preceding lists in the task rather than extraexperimental intrusions. For instance, Unsworth and Engle (2006b) found that the ratio of PLIs to ELIs in two complex span tasks (reading and operation span) was 3 to 1. Thus, PLIs are more likely to be included in the search set than ELIs, leading to increased search set and reduced probability of sampling target items.

Furthermore, those studies that have argued for the accrual of PI in complex span tasks have also suggested that lower scoring

participants are more susceptible than higher scoring participants to the buildup of PI across trials (Bowles & Salthouse, 2003; Bunting, 2006; May et al., 1999; Unsworth & Engle, 2006b). This differential susceptibility to PI results in lowered recall scores and an increased incidence of intrusion (particularly PLIs). Evidence in support of this comes from studies that have found that low WMC individuals are more likely than high WMC individuals to emit intrusions. For instance, Unsworth and Engle (2006b) found that low WMC individuals emitted nearly three times as many intrusions as high WMC individuals in two common complex span tasks, the majority of which were PLIs. Collectively, these findings suggest that PLIs are more likely than ELIs to be included in the search set and that low WMC individuals are more likely than high WMC individuals to include PLIs in their search.

According to the current framework, low WMC individuals use noisier contextual cues to delimit search sets not only in complex span tasks, but whenever a controlled/strategic search of SM needs to be undertaken. Additional evidence in support of this view comes from a study by Kane and Engle (2000). Kane and Engle had high and low WMC individuals perform a variant of the Brown–Peterson task (J. Brown, 1958; Peterson & Peterson, 1959) to assess the buildup of PI. High and low WMC individuals were shown a list of 10 category exemplars, followed by a distractor activity and then recall. Kane and Engle found that high and low WMC individuals recalled a similar number of words on the first trial, but that low WMC individuals recalled fewer and fewer items than high WMC individuals as the task progressed. That is, low WMC individuals were much more susceptible to the buildup of PI than were high WMC individuals (for a similar result with simple span tasks, see Dempster & Cooney, 1982; see also Friedman & Miyake, 2004, for a latent variable analysis of these effects).

In the current framework, these results can be explained by assuming that at retrieval, participants used a combination of both category cues (e.g., recall only animals) and internally generated temporal-context cues (e.g., recall items only from the current list) to delimit the search set. However, because similarity across both item type and temporal context is high, list discrimination is a problem, which leads to many PLIs being included in the search set and an overall reduction in probability correct. Furthermore, because low WMC individuals are poorer at list discrimination through the use of context cues, they are more affected by the accrual of PI than high WMC individuals, which leads to a steeper drop in performance across trials for low WMC than for high WMC individuals. Indeed, across two experiments high WMC individuals' proportion correct dropped roughly across the three trials from .62 to .49 to .39. Low WMC individuals, however, dropped roughly from .59 to .37 to .29 across the three trials. This steeper drop in performance for low WMC individuals compared

¹ Note that there are two major differences between typical versions of complex span tasks and the continuous distractor paradigm. One, complex spans typically require serial recall, whereas the continuous distractor task requires free recall. Two, there is not a filled retention interval in complex spans, but there typically is one in the continuous distractor task. Because the processing component in complex span tasks removes attention from the presented items, these items get displaced from PM and must, generally, be retrieved from SM. However, because there is typically a 0-s retention interval in these tasks, it is likely that the last presented item remains in PM at recall.

with high WMC individuals can be explained by simply assuming that low WMC individuals included more intruding items in their search sets than high WMC individuals. For instance, out of a list length of 10, assume that high and low WMC individuals have 7 recoverable targets and 3 nonrecoverable targets, leading to a probability of .70 of recalling an item on Trial 1. On Trial 2, assume that the cues used by high WMC individuals activate all of the current target items and 50% of the previous target items, leading to an overall search set of 15 items (7 recoverable targets, 3 nonrecoverable targets, and 5 PLIs). For low WMC individuals on Trial 2, assume that they too activate all the current target representations, but they also activate 100% of the previous target items, leading to an overall search set size of 20 (7 recoverable targets, 3 nonrecoverable targets, and 10 PLIs). Thus, the only difference between high and low WMC individuals is the number of PLIs in their search sets. The resulting probabilities of correctly recalling target items for high and low WMC individuals would then be .46 for high WMC and .35 for low WMC individuals. On Trial 3, assume that the same basic process as for Trial 2 is used, with high WMC individuals increasing their search sets by 5 items and low WMC individuals increasing their search sets by 10 items, leading to probabilities of correct recall of .35 for those with high and .23 for those with low WMC. Note that the theoretical probabilities overall are quite consistent with the actual results, even with fairly simple assumptions.

Thus far, we have argued that high WMC individuals are better than low WMC individuals at using cues to guide the search process of SM. In particular, we have argued that high WMC individuals use internally generated context cues to focus the search onto the current target representations and exclude (for the most part) irrelevant representations from being included in the search set. Low WMC individuals, on the other hand, use noisier internally generated context cues (context cues higher up in the hierarchy) than high WMC individuals, which leads to poorer recall of current target items. However, in these situations, what happens if participants are asked to recall items from the previous list as well? If high WMC individuals use constrained search sets that exclude previous list items, then they should actually demonstrate poorer performance than low WMC individuals, who do include these representations in their search sets.

Evidence consistent with this notion comes from a study from the directed forgetting literature by Delaney and Sahakyan (in press). In a typical directed forgetting task, participants are given a list of items and are told to either forget the items (forget condition) or remember the items for a later recall test (remember condition). Participants are then presented with another list of items, which they are told to remember. Later, participants are told to recall as many items as they can from both the first and the second list. Typically, in the forget condition, retention of items for the first list is poorer than for items in the second list, but in the remember condition, retention is about equal. Recently, Sahakyan and Kelley (2002) have suggested that the reason participants are able to forget items in the forget condition is because participants actively change their mental context, which at recall leads to a mismatch between encoding and retrieval contextual states and, hence, to poorer performance. To demonstrate this, Sahakyan and Kelley had participants perform a directed forgetting task in a forget condition, a remember condition, or a context change condition. In the context change condition, after the first list, partici-

pants were told to imagine themselves as invisible and to write down what they would do. Consistent with the context change hypothesis, Sahakyan and Kelley found that participants in the context change condition demonstrated poorer recall for List 1 items than did participants in the remember condition and demonstrated performance similar to that of participants in the forget condition. Furthermore, in a second experiment, Sahakyan and Kelley had participants perform a similar a task under remember, forget, or context change conditions. However, unlike in the previous experiment, some participants had their List 1 context reinstated at recall. According to a contextual change account, reinstating List 1 context at retrieval should facilitate recall and lead to better performance, which was indeed the case. When List 1 context was reinstated at recall, participants demonstrated a marked improvement in recall compared with when the context was not reinstated. Sahakyan and Kelley suggested that a primary reason for forgetting in directed forgetting experiments was the change in context.

Delaney and Sahakyan (in press) followed up on these findings by examining how individual differences in WMC would change as a function of the task manipulations. Specifically, in this study participants first performed the directed forgetting task in a remember condition, a forget condition, or a context change condition. After the directed forgetting task, all participants performed a complex span task (either operation span or counting span). As one would expect, Delaney and Sahakyan found that high WMC participants demonstrated better recall performance for List 1 items in the remember condition than low WMC participants. However, in both the forget condition and the context change condition, Delaney and Sahakyan found that high WMC participants demonstrated poorer recall performance for List 1 items. Thus, Delaney and Sahakyan found evidence for a situation in which having high WMC actually impaired recall performance for some items. Note, however, that this does not mean that high WMC individuals always demonstrate poorer performance than low WMC individuals when asked to recall information from the recent past, but rather that they have trouble recalling information when there is a large mismatch between the context at encoding and the context at retrieval. If, as in Sahakyan and Kelley's (2002) study, context were reinstated at retrieval, we would expect high WMC individuals to perform better than low WMC individuals. Clearly, more work is needed in this area to determine exactly why low WMC individuals were outperforming high WMC individuals in these situations. At the very least, the results obtained by Delaney and Sahakyan demonstrate that high WMC individuals are not always better at recall than low WMC individuals.

In this section, we have suggested that recall tasks require the use of internally generated contextual cues to focus search on relevant representations in SM. Furthermore, we have suggested that recall deficits typically demonstrated by low WMC individuals can be accounted for by assuming that they use noisier contextual cues than high WMC individuals, which leads to more irrelevant items being included in their search sets compared with high WMC individuals. However, in some situations where representations from previous lists need to be recalled, as in directed forgetting experiments, having a constrained search set can actually hinder performance. In such cases, low WMC individuals demonstrate superior recall performance compared with high WMC individuals. In the next section, we briefly discuss situations

in which internally generated contextual cues are combined with externally presented cues to focus search on target items.

Recognition and Cued Recall

Unlike basic free recall tasks where target information has to be retrieved with internally generated cues only, basic recognition and cued-recall tasks provide participants with an external cue to aid in retrieval. For instance, in a standard recognition memory task, participants are presented with a series of items, and at test they are given either items that were previously presented or items that were not presented. Participants are then required to judge whether the item is old (was previously presented) or new (was not previously presented). Several theories suggest that performance in these tasks is driven by two separate mechanisms: a fast-acting, fairly automatic familiarity process and a slower, more controlled recollection process (see Yonelinas, 2002, for a review). Thus, when given an item at test and asked to judge whether they saw that item previously, participants can base their responding either on an automatic familiarity signal or on a controlled recollective/search process. In many cases, these two processes lead to the same response. However, in situations requiring finer discriminations among items, the familiarity processes may lead to an incorrect response, and thus there is a greater need for the controlled recollection process to recover information related to the target item.

As with the studies above on recall, we suggest that individual differences in WMC occur only when a controlled/strategic search of SM is required. Thus, if familiarity and recollection can be considered as automatic and controlled aspects of retrieval (e.g., Jacoby, 1991), then individual differences in WMC should occur only for the recollection process and not for the familiarity process. Evidence in support of this view comes from a study by Oberauer (2005) in which participants performed a number of WMC tasks and a number of recognition memory tasks. In particular, participants performed either a local recognition task or a global recognition task. In both tasks, items were presented in separate frames on the computer screen. In the global recognition task, participants were given an item and were required to indicate whether the item belonged to the current set. Performance on this task could be based either on familiarity or recollection. In the local recognition tasks, participants were given an item presented in one of the frames, and they had to indicate whether that item belonged in that frame. Oberauer argued that this task required mainly recollection because not only does a judgment have to be made concerning whether the item is a part of the current set, but a judgment also has to be made concerning whether the item is in the correct frame. On some trials, an item may be presented from the current set (leading to a strong familiarity response), but it may be placed in the wrong frame, thus requiring recollection of particular contextual information for accurate responding.

Using these recognition tasks and the WMC tasks, Oberauer (2005) performed several latent variable analyses to determine how familiarity and recollection would correlate with performance on the WMC tasks. If individual differences in WMC reflect differences in global memory functioning—where low WMC individuals always perform more poorly than high WMC individuals (although see the work on directed forgetting described earlier)—then estimates of both familiarity and recollection should be cor-

related with performance on the WMC tasks. If, however, individual differences in WMC partially reflect differences in controlled/strategic search, as argued here and elsewhere (e.g., Rosen & Engle, 1997), then only estimates of recollection should correlate with performance on the WMC tasks. Across all analyses, Oberauer found evidence only for a relation between WMC and recollection. No evidence was found suggesting a relation between WMC and familiarity. Thus, individual differences in WMC can be conceptualized as differences in controlled/strategic search of SM. When information can be retrieved automatically, WMC does not play a role in retrieval.

Further evidence for this assertion comes from a series of experiments conducted by Conway and Engle (1994). In these experiments, participants performed a probe-recognition task modeled after Sternberg's (1966) article. In these experiments, participants learned sets of 2, 4, 6, or 8 items associated with a digit that reflected the set size. For instance, the letters *Z, G, R, B* might be associated with the digit 4. Participants learned these sets to a criterion of three perfect recall cycles. During a verification stage, participants were presented with a digit (e.g., 4) followed shortly after by a letter (e.g., *G*) and were required to make a speeded response indicating whether the letter was part of that set. In some conditions, each item was associated with only one set (e.g., *G* always with 4). In these conditions, responding can be based mainly on familiarity processes, as in the global recognition task of Oberauer (2005), and thus we would not expect high and low WMC individuals to differ in performance. Consistent with this, Conway and Engle found that high and low WMC individuals did not differ in either speed or accuracy of responding. In other conditions, however, items belonged to two different sets (e.g., *G* in both the set of 4 and the set of 8 items). Similar to the local recognition task used by Oberauer, accurate responding in this task requires the recollection process to discriminate between the different sets in which the items were presented. That is, because an item is associated with two contexts (the set of 4 and the set of 8 items), the external cue activates both sets and internally generated cues are needed to focus the search on only the correct set. In such a case, individual differences in WMC should appear because of the need to constrain the search on the relevant set and exclude the irrelevant set. Conway and Engle demonstrated precisely that. When items were associated with overlapping contexts (similar to the overlap in context seen in the PI experiments above), low WMC individuals were slower to correctly respond than high WMC individuals. Thus, only in situations where a controlled search was required to discriminate between relevant and irrelevant representations did individual differences in WMC appear.

This same basic effect has recently been replicated (Bunting, Conway, & Heitz, 2004) in the context of a fact retrieval task (Anderson, 1974; see also Cantor & Engle, 1993). In this task, participants learn a set of propositions, such as "The teacher is in the park," "The lawyer is in the park," "The lawyer is in the boat," and so on. The number of sentences that share a common concept (e.g., lawyer or park) is manipulated. Some concepts are linked to only one sentence, making for fairly accurate and rapid retrieval of information, while other concepts are associated with many sentences, and retrieval is less accurate and delayed. In this task, a *fan effect* is found such that the more sentences that are linked with a given concept, the longer it takes to indicate whether the sentence was presented. Bunting et al. (2004) manipulated the extent to

which some concepts were uniquely associated with a given concept or whether they were linked to multiple concepts as Conway and Engle (1994) had done. Similar to Conway and Engle's findings, Bunting et al. found that high and low WMC individuals differed only when representations were associated with multiple concepts, leading to slower and less accurate retrieval. In both Conway and Engle's study and Bunting et al.'s study, high and low WMC individuals did not differ in a probe recognition experiment when the external cue uniquely specified the target information. In these situations, responses are likely based on fast-acting familiarity processes. Differences did appear, however, when the external cue activated representations associated with multiple contexts. In these conditions, the external cue needed to be combined with internally generated cues to constrain the search only on the relevant representations. Because low WMC individuals are impaired in their ability to use internally generated context cues to guide the search process, their performance is hindered compared with that of high WMC individuals.

Cued recall is another situation in which externally presented and internally generated cues have to be combined to focus search on relevant items and in which individual differences in WMC are apparent. In typical paired associates cued-recall participants are presented with pairs of items during a learning phase and later (at testing) are given one of the items and are asked to recall the other item. Similar to recollective search processes in recognition tasks, in cued recall an externally presented cue is combined with internally generated cues to guide the search process. However, cued recall and recognition differ in the response that is required. In recognition tasks, participants are required to judge whether an item is new or old, but in cued recall participants are required to generate a specific item on the basis of the cues presented.

In cued recall when items are associated with multiple contexts, noisy internally generated context cues can result in the search not being focused enough on the relevant context leading to PI and intrusions from prior contexts. In paired-associates learning, PI is tested by having participants learn paired associates, such as *bird-bath* and *knee-bend* in one list, and then having them learn a new list of paired associates that consists of the same cue words from List 1 (e.g., *bird-dawn*, *knee-bone*; A-B, A-C). That is, on List 2, the paired associates might be *bird-dawn* and *knee-bone*. The typical finding is that individuals are slower to learn List 2 and have more List 1 intrusions during List 2 learning compared with a control group that learned a new set of cue-responses terms. According to a context retrieval view (e.g., Mensink & Raaijmakers, 1988), the reason for the interference is that at retrieval, the external cue (e.g., *bird*) activates both the current target representation (e.g., *dawn*) and the previous target representation (e.g., *bath*). For accurate responding, internally generated context cues are needed to focus the search on only the most recent target representation (e.g., *dawn*). Any noise in the context cues that are being used results in slower and less accurate responding. Thus, on the basis of the current view, one would expect that low WMC individuals should be both slower to learn List 2 associates and more likely than high WMC individuals to intrude List 1 items during List 2 learning. Rosen and Engle (1998) demonstrated just that. In a paired-associates task of the type discussed earlier, low WMC individuals were slower than high WMC individuals to learn List 2 responses when the cue words were shared with List

1, and low WMC individuals were much more likely than high WMC individuals to intrude List 1 items during List 2 learning.

Similar to Rosen and Engle's (1998) study, Daniels (2003) had high and low WMC individuals learn cue-target pairs. Specifically, in the first phase, participants learned cue-fragment pairs in which the fragment could be completed with one of two related words (e.g., *bed-s_ee_* could be solved as *bed-sheet* or *bed-sleep*). During the second phase, participants studied a list composed of only one of the cue-target pairs. At test, participants were given cue-fragment pairs and were told to solve them with words from the studied list. Thus, to retrieve the correct item, controlled recollection was required in which the cue was combined with internally generated context cues to specify only the recent cue-target pair. Relying only on automatic retrieval processes would likely retrieve the irrelevant cue-target pair. As such, Daniels hypothesized that low WMC individuals would demonstrate poorer performance than high WMC individuals, which was the case. Furthermore, using equations from Jacoby's process dissociation procedure (e.g., Jacoby, Debner, & Hay, 2001), Daniels found that high and low WMC individuals differed only in estimates of control and not in estimates of automatic retrieval. These same basic effects were found with a spatial version of the task as well. As with Rosen and Engle's study, these results suggest that high and low WMC individuals differ when controlled retrieval from SM is required on cued-recall tasks.

In this section, we have shown that individual differences in WMC are related to individual differences in the ability to engage in a controlled/strategic search of SM. The ability to use internally generated context cues to guide the search of SM differentiates individuals high and low in WMC across a number of tasks and domains (see Friedman & Miyake, 2004, for a latent variable analysis of these effects). Thus, individual differences in WMC are not localized only to differences on complex span tasks, but differences occur whenever a controlled search of memory is required, particularly in the presence of PI.

Individual Differences in WMC, Active Maintenance, and Controlled Search in Immediate Free Recall

In the preceding sections, we argued that WMC differences in a number of tasks can be interpreted as reflecting differences in the ability to actively maintain task relevant information in PM and to retrieve task relevant information from SM. Here we examine this dual-component model more thoroughly by examining maintenance and retrieval in the same task: immediate free recall. Generally, when testing dual-component models of memory, immediate free recall has typically been the cornerstone paradigm. Research has shown that individuals are very good at recalling the last few presented items (recency) but are much worse at recalling earlier items (prerecency). Furthermore, some manipulations tend to affect the prerecency portion of the serial position curve while sparing the recency component, including manipulations of presentation rate, list length (Murdock, 1962), and PI (Craik & Birtwistle, 1971). However, simply adding a distractor task after the presentation of the last item tends to wipe out the recency advantage (Glanzer & Cunitz, 1966; Postman & Phillips, 1965). These dissociations provide support for the view that two components (PM and SM) are contributing to performance in immediate free recall. On the basis of this evidence, several researchers have

proposed methods to examine the contributions of PM and SM in immediate free recall (see M. J. Watkins, 1974). These methods typically show that approximately four items can be retrieved from PM, whereas the other items must be retrieved from SM.

Before examining WMC differences in immediate free recall, it is important to demonstrate that the processes being tapped in immediate free recall are the same as those in typical WMC measures and, thus, that an examination of immediate free recall is warranted. To do so, we reanalyzed data from Engle et al. (1999). Engle et al. administered a number of simple and complex memory span tasks, measures of fluid intelligence, and measures of free recall to 133 undergraduate students. Additionally, Engle et al. acquired verbal and quantitative SAT scores for each participant. To see whether immediate free recall could be considered as a measure of WMC, we submitted the three complex span tasks from Engle et al.'s study (reading span, operation span, and counting span) along with immediate free recall to a confirmatory factor analysis. If immediate free recall can be considered as a measure of WMC, we should see that the model fits the data and that immediate free recall loads as highly as the complex span tasks on the resulting factor. The results from the confirmatory factor analysis suggested that immediate free recall loaded highly on the WMC factor (.71) and that this loading was similar to the loadings of the complex span tasks (e.g., reading span = .61; operation span = .79; counting span = .59).² Next, we examined the relation of the WMC factor with a Fluid Abilities factor and an SAT factor. The resulting model is shown in Figure 3. The model suggests that

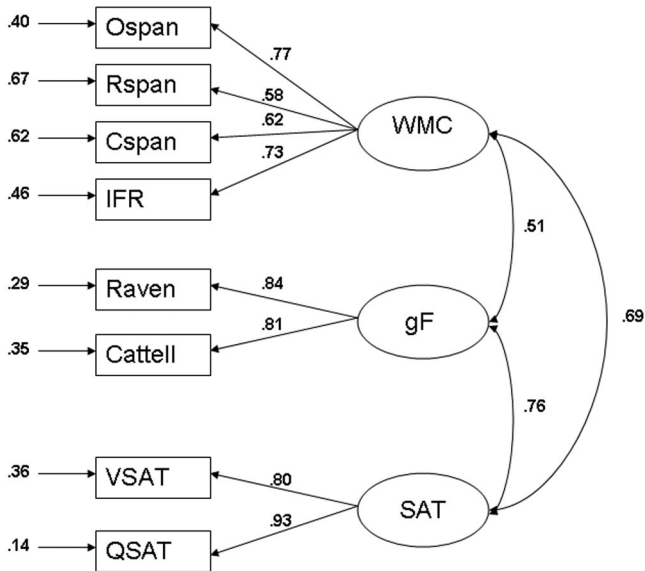

Figure 3. Path model for the structural equation analysis of the relation between the latent variables for working memory capacity (WMC), the Scholastic Aptitude Test (SAT), and fluid abilities (gF). The numbers on the paths leading from the constructs (circles) to the manifest variables (rectangles) are the loadings of each measure on that construct. The numbers for the double headed paths between the memory variables are the correlations between the two constructs. All paths and loadings are significant at the .05 level. Ospan = operation span; Rspan = reading span; Cspan = counting span; IFR = immediate free recall; VSAT = Verbal Scholastic Aptitude Test; QSAT = Quantitative Scholastic Aptitude Test.

the WMC factor is related to both the Fluid Abilities factor and the SAT factor with a magnitude of correlation similar to that found in Engle et al.'s (1999) original study.³

These analyses suggest that immediate free recall can be considered as a measure of WMC along with complex span measures. Furthermore, this finding highlights the fact that the predictive power of WMC does not rest exclusively on tasks that simultaneously tap storage and processing functions; rather, other memory tasks can do a similar job of predicting higher order cognitive functions (Oberauer, Süb, Schulze, Wilhelm, & Wittmann, 2000; Unsworth & Engle, 2006a). This suggests that the mechanisms that drive recall in the complex span tasks are the same as those in immediate free recall and that these mechanisms contribute to the predictive power of WMC measures. Thus, we suggest that a detailed examination of performance on immediate free recall in terms of individual differences in WMC can inform researchers about the nature of WMC and its link to higher order cognitive processes. In particular, the main predictions of the model are as follows: As the size of the search set increases because of intrusions, (a) the probability of sampling an intrusion should increase, (b) the probability of sampling a target item should decrease, and (c) the time until a target item is sampled should increase. These effects should be greater for individuals with lower WMCs.

To test these predictions, high and low WMC individuals performed an immediate free recall task, and both accuracy and response latency were measured for each individual. Note that the next few sections (up to the General Discussion section) include data from this new experiment (see the Appendix for methods and statistical analyses).

Serial Position Effects and Probability of First Recall

The proposed framework accounts for serial position effects much the same way classic dual store models do (e.g., Atkinson & Shiffrin, 1968). Recency items in immediate free recall should have a high probability of recall given that they are maintained and unloaded from PM. Pre-recency items, however, are retrieved by means of a probabilistic search of SM, and thus should have a lower probability of recall. Novel to the current approach is the idea that individuals who differ in WMC should differ in both their ability to maintain items in PM and their ability to retrieve items from SM. Thus, individual differences in WMC should occur for both recency and pre-recency items as is shown in Figure 4. As expected, high WMC individuals retrieved more items than low WMC individuals ($M = .55, SE = .014$ vs. $M = .44, SE = .015$), and this occurred for both recency and pre-recency items.

² The resulting model fit the data quite well, $\chi^2(2, N = 133) = 3.07, p > .21$; root mean square error of approximation = .06, standardized root mean squared residual = .03, normed fit index = .98, comparative fit index = .99. The root mean square error of approximation and the standardized root mean squared residual reflect the average squared deviation between the observed and reproduced covariances. The normed fit index and the comparative fit index reflect the proportion of the observed covariance matrix explained by the model. Normed fit index and comparative fit index values greater than .90 and standardized root mean squared residual values less than .05 are indicative of acceptable fit (Kline, 1998).

³ The fit of this model was also good, $\chi^2(17, N = 133) = 22.43, p > .16$; root mean square error of approximation = .05, standardized root mean squared residual = .04, normed fit index = .97, comparative fit index = .99.

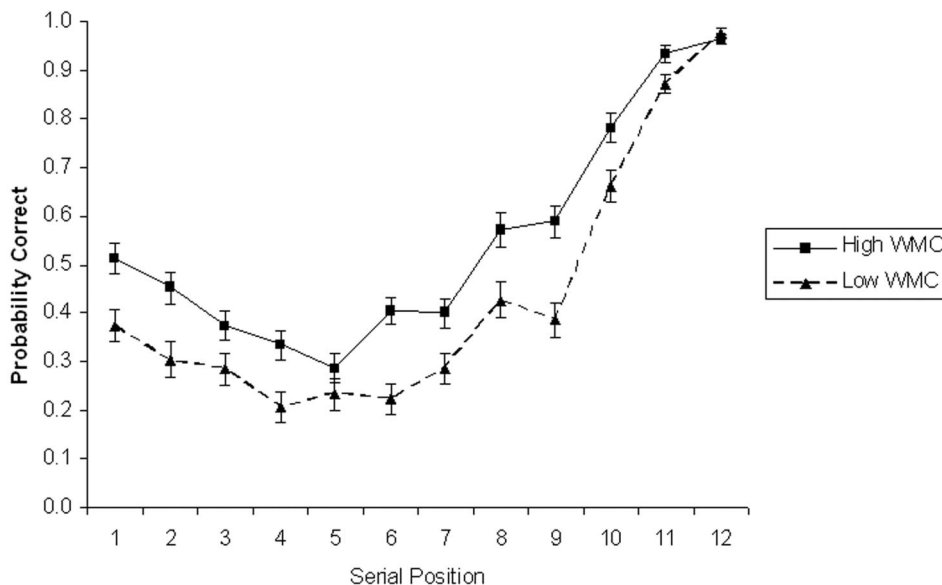

Figure 4. Probability correct as a function of serial position and working memory capacity (WMC). Error bars represent one standard error of the mean.

According to the model, recency items are unloaded from PM, and then retrieval from SM begins. If it is the case that high WMC individuals are better at maintaining items in PM than are low WMC individuals, then a better examination of the dynamics of unloading from PM may be informative. One way of examining recency effects is to plot the probability of first recall (e.g., Howard & Kahana, 1999). Probability of first recall is simply the number of times the first word recalled comes from a given serial position divided by the number of times the first recalled word could have come from that serial position. For instance, if a person begins recall with the last presented word 9 out of 10 times, then the probability of first recall for that serial position would be .90. Because high WMC individuals maintain more information in PM than low WMC individuals, we would expect the probability of unloading any given item first would be distributed over more items for high WMC individuals, leading to lower probability of first recall functions for high than for low WMC individuals. Figure 5 shows the computed probability of first recall for high and low WMC individuals on the basis of the new experiment presented in the Appendix.⁴

As can be seen, the functions suggest that both groups tended to begin recall with the last presented word, but that low WMC individuals were more likely than high WMC individuals to begin recall with the last presented word. Additionally, the results suggest that more recency serial positions had probabilities of first recall greater than zero for high WMC individuals than low WMC individuals. That is, high WMC individuals tended to distribute their probabilities of first recall over more serial positions than did low WMC individuals.

Estimates of Primary and Secondary Memory

The serial position effects and the effects of probability of first recall are both in accord with the notion that high WMC individ-

uals recall more items from both PM and SM. To get estimates of the capacity of PM and examine WMC differences in the number of items recalled from SM, the contributions of PM and SM were estimated on the basis of Tulving and Colotla's (1970) method. In this method, the number of words between a given word's presentation and recall is tallied. If there were seven or fewer words intervening between presentation and recall of a given word, the word was considered to be recalled from PM. If more than seven words intervened between presentation and recall, the word was said to be recalled from SM. Using this or similar methodology, a number of investigators have found differences between PM and SM items (e.g., Craik, 1971; Craik & Levy, 1976; M. J. Watkins, 1974). Relevant data from the new experiment presented in the Appendix and from Engle et al. (1999) are presented in Table 1. In line with previous research, the overall estimate of the capacity of PM was roughly three and a half items (e.g., M. J. Watkins, 1974). Additionally, high WMC individuals retained more information in PM and retrieved more information from SM than low WMC individuals.

⁴ Recently, Davelaar et al. (2005) modeled output dynamics for their buffer component in terms of both time in the buffer (episodic strength) and activation levels. This framework suggests that the last item presented is not unloaded first, but rather items three or four positions from the end are unloaded first. Davelaar et al. cited results from Murdock (1962) as evidence for such an output process. However, as shown in Figure 5 of the present article (see also Howard & Kahana, 1999), participants tend to begin recall with the last presented item instead of an item presented three or four positions back. A notable difference between the results used by Davelaar et al. and our own results is that Davelaar et al. relied on work by Murdock in which the items were presented auditorily. The current work and the work of Howard and Kahana (1999) relied on items that were presented visually. Thus, it would seem that the output dynamics from a short-term buffer are determined in part on the basis of presentation modality of the items (see Nilsson, Wright, & Murdock, 1975).

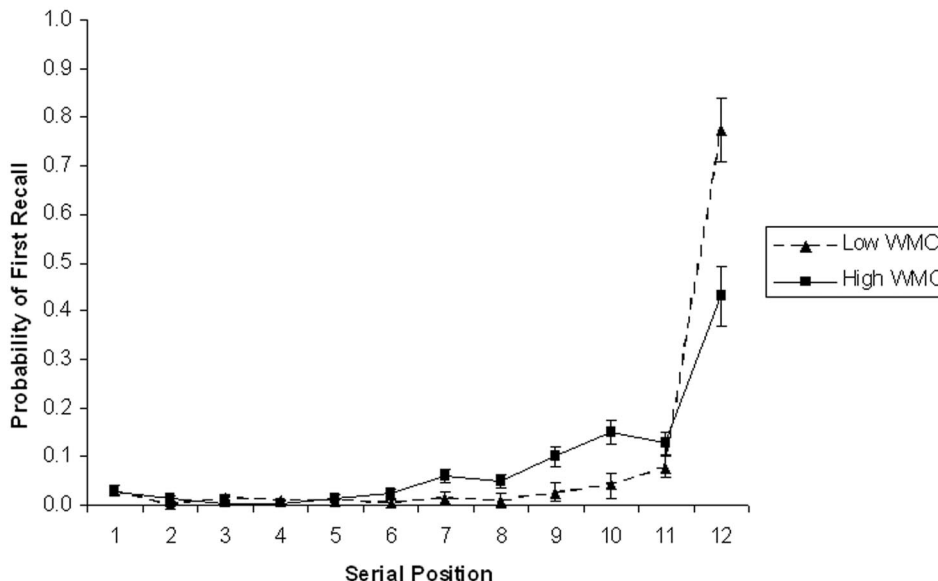

Figure 5. Probability of first recall as a function of serial position and working memory capacity (WMC). Error bars represent one standard error of the mean.

Given that high WMC individuals have higher estimates of both PM and SM than low WMC individuals, it is important to ask to what extent these two components are independent. For instance, previous research has suggested that PM and SM are weakly correlated (see, e.g., Carroll, 1993; Engle et al., 1999). Furthermore, in the new experiment reported here, estimates of PM and SM were moderately correlated ($r = .29, p < .05$) with 49 participants. Importantly, however, that each component accounted for unique variance in the operation span (Ospan). Conducting a series of partial correlation analyses suggested that the correlation between PM and Ospan, partialing out SM, dropped slightly as did the correlation between SM and Ospan, partialing out PM (both went from $r_{pb} = .53$ to $pr_{pb} = .46, p < .01$). Furthermore, the correlation between PM and SM, partialing out Ospan, was reduced to practically zero ($pr_{pb} = .01, p > .94$). This suggests that estimates of PM and SM contribute largely independent variance in one measure of WMC. If PM and SM are truly independent components, then it is possible that there are four separate profiles of individuals represented as high in both components, high in one component and low in the other, and low in both components. We

plan to examine this possibility more thoroughly in the future as it would suggest that WMC is not a unitary function, but rather represents a conglomeration of separate abilities.

Another prediction of the current framework, and one highlighted by Davelaar et al. (2005), is the idea that items within PM should be impervious to PI but that items in SM are susceptible to PI (e.g., Cowan et al., 2005; Craik & Birtwistle, 1971; Halford, Mayberry, & Bain, 1988). If it is the case that PI affects only items retrieved from SM, we should see that the number of items retrieved from SM decreases, but we should see no change for items retrieved from PM. As shown in Figure 6, the new experiment presented in the Appendix demonstrates a nice replication of the findings of Craik and Birtwistle's (1971) Experiment 1. The number of items retrieved from PM remained fairly constant at about 3.4 for the different lists, but the number of items retrieved from SM decreased relatively rapidly across the lists. Thus, PI selectively affects retrieval from SM, but does not influence the number of items that can be actively maintained in PM.

Recall Errors

According to the model, low WMC individuals search through a larger set of items than high WMC individuals, including items from previous trials. To examine this possibility more thoroughly, it is important to examine the errors that are output during the recall period. Here errors were classified as previous list intrusions (items from previous lists), extralist intrusions (items not presented in any other list), or repetitions (items from the current list that had already been recalled). Shown in Table 2 are the average numbers of each error type as a function of WMC for the new experiment presented in the Appendix.

As predicted, low WMC individuals are more likely to output PLIs than high WMC individuals, indicating that low WMC individuals include more PLIs in their search sets than high WMC individuals. Furthermore, according to the current framework,

Table 1
Mean Estimates of Primary Memory (PM) and Secondary Memory (SM) by Complex Span for the Current Study and Engle et al. (1999)

WMC	Current				1999			
	PM		SM		PM		SM	
	M	SD	M	SD	M	SD	M	SD
High	3.66	0.44	2.99	0.80	3.63	0.54	2.25	0.92
Low	3.19	0.32	2.07	0.71	3.43	0.33	1.39	0.60

Note. WMC = working memory capacity.

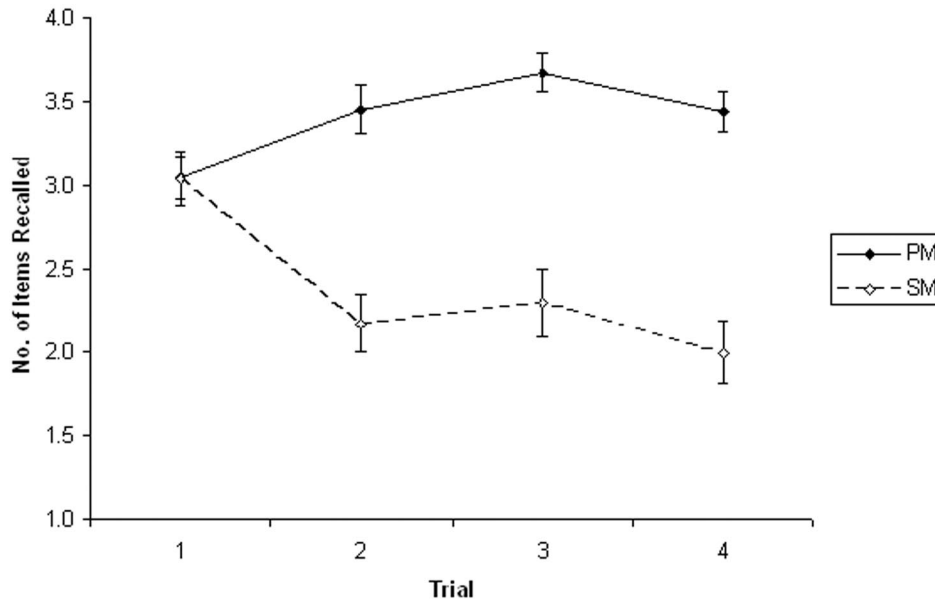

Figure 6. Number of items recalled as a function of trial number and memory estimate (primary memory [PM] vs. secondary memory [SM]). Error bars represent one standard error of the mean.

these PLIs should come primarily from the immediately preceding list. Therefore, for each PLI we computed the number of lists back the intrusion came from. Shown in Figure 7 are the lag functions for both high and low WMC individuals for the new experiment. The results suggested that the majority of PLIs tended to come from one list back and that the probability of a PLI decreased the further back in time a list was presented. That is, PLIs showed a recency effect with most intrusions coming from one or two lists back from the current list (e.g., Bennett, 1975). Furthermore, this effect was similar for high and low WMC individuals. Low WMC individuals tended to intrude more items from previous lists than high WMC individuals, but for both groups these intrusions tended to come from recently presented lists.

Differences in Search Set Size as Indicated by Response Latency

A key notion of the present framework is that the larger the search set, the longer, on average, it should take to find the desired item. McGill (1963) has demonstrated that assuming a constant sampling

time per item, a simple random sampling-with-replacement process predicts exponentially declining rates of recall and cumulative exponential recall curves (see also Rohrer & Wixted, 1994; Vorberg & Ulrich, 1987). Bousfield, Sedgewick, and Cohen (1954) and others (see also Indow & Togano, 1970; Roediger, Stellon, & Tulving, 1977) have found that cumulative latency distributions are well described by the cumulative exponential,

$$F(t) = N(1 - e^{-\lambda t}), \tag{4}$$

where $F(t)$ represents the cumulative number of items recalled by time t , N represents asymptotic recall, and λ represents the rate of approach to asymptote.

On the basis of a detailed review of the literature of the random search model, Wixted and Rohrer (1994) have argued that the size of the search set affects the rate of approach to asymptote (λ). Specifically, these authors argued that the larger the set one is searching from, the slower one is in reaching asymptotic recall levels. This makes sense; the larger the search set, the lower the probability of sampling any given item and, hence, the longer it takes to find the desired item. Wixted and Rohrer (1994) suggested that λ provides an index of the breadth of search. As an empirical example of this point, Wixted and Rohrer (1993) examined how the buildup of PI would effect retrieval latency. Assuming that the search set gets larger as PI builds, they hypothesized that retrieval latency should slow and λ should decrease. To test this prediction, they had participants perform a PI build-and-release variant of the Brown-Peterson task, where the first three trials were all from the same category and the fourth trial was from a different category (Gardiner, Craik, & Birtwistle, 1972). Consistent with the predictions, they found that as PI increased, the number of items recalled decreased and λ decreased. This suggested that the size of the search set increased as PI increased when using the same category. However, in the release condition, the number of items recalled

Table 2
Mean Number of Each Error Type per List by Complex Span

WMC	Error type					
	PLI		ELI		Repeat	
	<i>M</i>	<i>SD</i>	<i>M</i>	<i>SD</i>	<i>M</i>	<i>SD</i>
High	.22	.17	.15	.14	.21	.18
Low	.37	.30	.21	.33	.27	.18

Note. WMC = working memory capacity; PLI = previous list intrusion; ELI = extralist intrusion; repeat = repetition error.

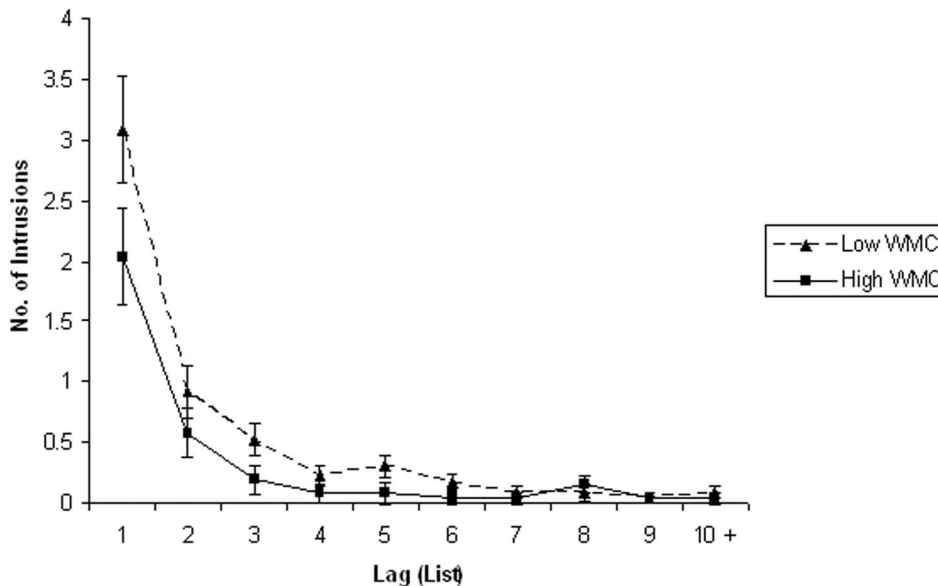

Figure 7. Frequency of previous list intrusion errors as a function of lag (list) and working memory capacity (WMC). Error bars represent one standard error of the mean.

increased and λ increased slightly. Wixted and Rohrer (1993) argued that the results suggested that as PI built, the search set became progressively larger because the search set was delimited to all category instances based on the retrieval cue. That is, N remained the same across trials, but PLI increased. However, changing to a new category cue for the release condition led to a reduction in the size of the search set because the retrieval cue specified only the new category instances and thus excluded category instances from the previous trials. On the basis of this and other evidence, Wixted and Rohrer (1993, 1994; see also Rohrer & Wixted, 1994) have offered compelling evidence that the random search model and estimates obtained from fitting the cumulative exponential to cumulative latency distributions provides a useful framework for interpreting temporal aspects of free recall performance as related to theoretical differences in search set size.

A novel way of testing the prediction that low WMC individuals are poorer at using contextual cues to delimit their search sets is to examine response latency in free recall paradigms. According to the random search model, if low WMC individuals are searching for items in larger search sets than high WMC individuals, they should have longer response latencies than high WMC individuals. In particular, the random search model suggests that low WMC individuals should approach asymptotic levels more slowly than high WMC individuals. In line with the results of Wixted and Rohrer's (1993) PI experiment, low WMC individuals should have lower asymptotic levels (N) than high WMC individuals (as already shown in the accuracy analyses) and should have smaller values of λ than high WMC individuals. Fitting the cumulative exponential function to each participant's cumulative latency distributions and then aggregating the resulting parameter estimates across individuals for each WMC group show this to be the case. Results from the new experiment are shown in Figure 8 and Table 3. The results indicate that low WMC individuals recall fewer items than high WMC individuals and are slower than high WMC

individuals to recall items, indicating that low WMC individuals search through more information than high WMC individuals at retrieval.

Although the cumulative latency distributions provide initial support for the hypothesis that high and low WMC individuals differ in the size of their search sets, an examination of individual response latencies can also be informative. That is, the parameter estimates that are derived from fitting the cumulative exponential to the cumulative latency distributions tend to be somewhat variable, leading to low statistical power. Additionally, the cumulative latency distributions provide a gross measure of response latency during the recall period. Therefore, WMC differences in mean response latency were examined. Here response latency refers to the time in the recall period when a given response was emitted. Thus, if responses were emitted 3, 5, and 10 s into the recall period, mean response latency would be 6 s. As Rohrer and Wixted (1994) have shown, mean response latency equals the reciprocal of λ , and thus, high WMC individuals should have shorter mean response latency than low WMC individuals. In the new experiment, this was indeed the case. High WMC individuals emitted their responses, on average, earlier in the recall period than low WMC individuals ($M = 5.93$ s, $SE = 0.28$ vs. $M = 6.80$ s, $SE = 0.30$).

Next, the growth of response latency for high and low WMC individuals was examined. The first question addressed in this analysis was whether high and low WMC individuals begin outputting items at the same time, or whether low WMC individuals begin emitting responses later in the recall period. It is possible that the reason low WMC individuals have longer mean response latencies than high WMC individuals is because they simply start recall at a later time than high WMC individuals. That is, it may take low WMC individuals longer to get into what Tulving (1983) has called a *retrieval mode*. If this is the case, then low WMC individuals' first response should be emitted much later in the

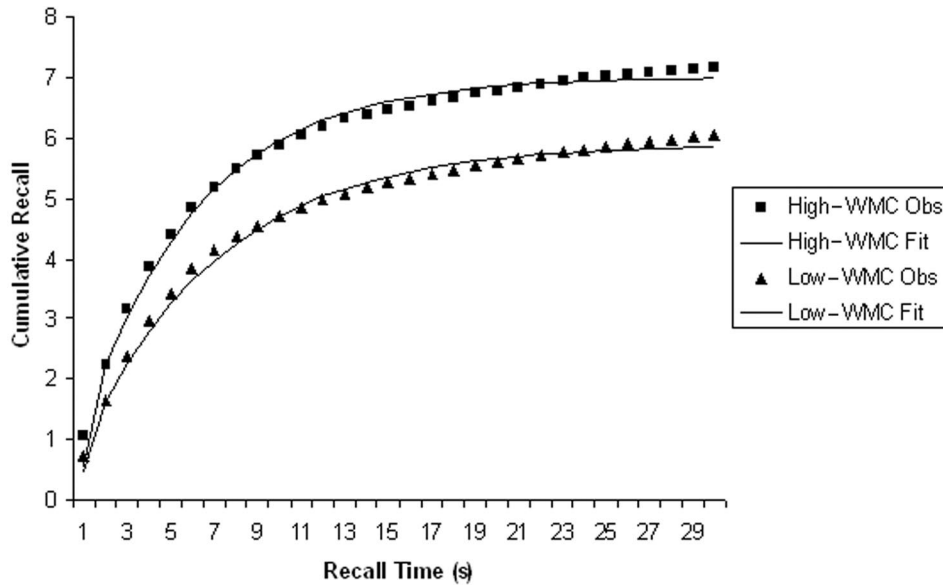

Figure 8. Cumulative recall functions as a function of recall time and working memory capacity (WMC). The symbols represent the observed data and the solid lines represent the best fitting exponential (Equation 4). Obs = observed.

recall period than that of high WMC individuals, but after that their response latency growth functions are parallel. If, however, low and high WMC individuals begin recall at the same time, the first response for both groups should be emitted at approximately the same time, and the functions should diverge thereafter. Shown in Figure 9 are the resulting response latency growth functions for high and low WMC individuals for the first six responses for the new experiment. Only the first six responses are shown because low WMC individuals recalled approximately six words on average. As can be seen, high and low WMC individuals begin recall at approximately the same time during the recall period, but after the first few responses, low WMC individuals emit their responses at later points in the recall period than high WMC individuals.

Thus, even when the number of items that were emitted is equated for high and low WMC individuals, low WMC individuals emit their responses at a slower rate than high WMC individuals after the first few responses. This is precisely what one would expect if, as the model suggests, the first few responses are unloaded from PM, whereas the rest are retrieved from SM. High and low WMC individuals should not differ in the time it takes to

unload items from PM, but low WMC individuals should be slower to emit responses from SM because of the extra time it takes to search for target items in a large search set.

Interresponse Times

Interresponse times (IRTs) provide perhaps the clearest picture of the retrieval process. Here IRTs refer to the time between the beginning of recall of one item to recall of the next item. Analyses of IRTs have shown that recall items within a categorical cluster have faster IRTs, whereas between-cluster IRTs are much slower (e.g., Wixted & Rohrer, 1994). Furthermore, Murdock and Okada (1970; see also Rohrer, 1996) have found that an examination of IRTs gives an indication of the number words yet to be recalled. That is, regardless of how many items are actually recalled, IRTs give a good account of how many items are in the search set.

IRTs provide important information about the dynamics of retrieval. Therefore, we examined the growth functions for IRTs for the first six responses as was done when examining response latency. Note that these analyses are somewhat redundant with the response latency analyses, but these analyses examine the time between recalls excluding the time between the recall period onset and the first recall. Thus, these analyses should provide a fairly clear picture of the retrieval process for both unloading from PM and searching from SM. As noted previously, if the first few items are unloaded from PM (as suggested by the probability of first recall analyses), then these items should be associated with fast and nearly equivalent IRTs (see also Metcalfe & Murdock, 1981). Items that are retrieved from SM, however, should have slower IRTs that get larger as more items have been recalled. Shown in Figure 10 are the resulting IRT growth functions for high and low WMC individuals from the new experiment presented in the Appendix.

The results suggest that the first few items are recalled rapidly and fairly equivalently for both WMC groups and suggest similar

Table 3
Parameter Estimates Obtained From Fitting the Cumulative Latency Distributions to a Cumulative Exponential as a Function of Complex Span

WMC	Individual estimates				Group estimates			
	λ	SD	N	SD	λ	SD	N	SD
High	0.20	0.07	7.07	1.10	0.19	N/A	7.01	N/A
Low	0.17	0.05	5.93	1.02	0.16	N/A	5.90	N/A

Note. WMC = working memory capacity.

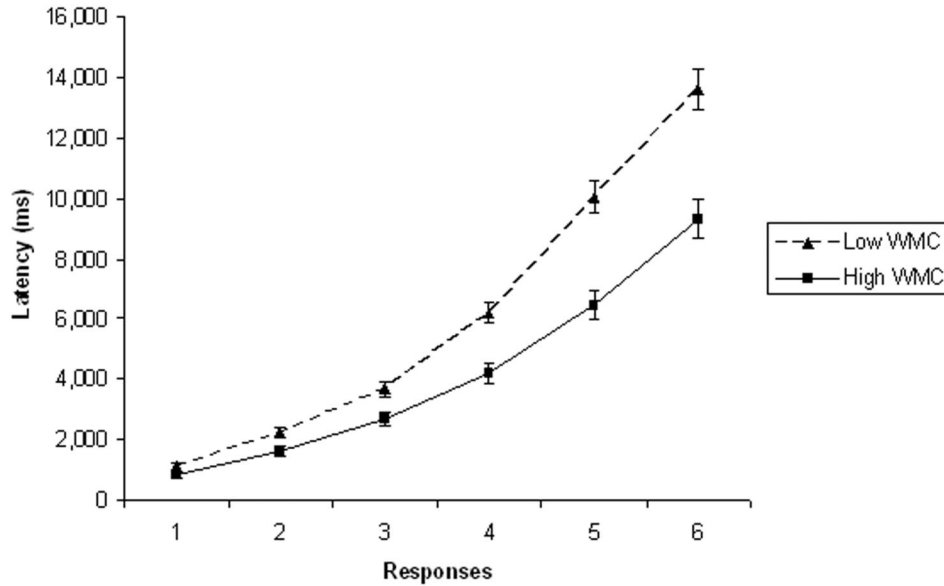

Figure 9. Recall latencies for the first six responses as a function of working memory capacity (WMC). Error bars represent one standard error of the mean.

unloading rates from PM. Subsequent items, however, are associated with slower IRTs, and large differences occur for high and low WMC participants, with low WMC individuals having much slower IRTs than high WMC individuals. These results complement the response latency results by demonstrating that high and low WMC individuals do not differ much in the time it takes to retrieve the first few items, but that low WMC individuals are much slower than high WMC individuals at retrieving subsequent items. This view is compatible with Cowan and colleagues' (Cowan, 1992; Cowan et al., 1998, 2003) interpretation of interword pauses in both simple spans and complex spans. Both views

suggest that after an item has been retrieved, a search of memory is undertaken to retrieve new target items. Furthermore, both views suggest that there are important individual differences in this memory search process in which some participants are searching through more items than others, which leads to differences in IRTs and interword pauses.

General Discussion

In this article, we have presented a model of individual differences in WMC in terms of a dynamic PM component and a

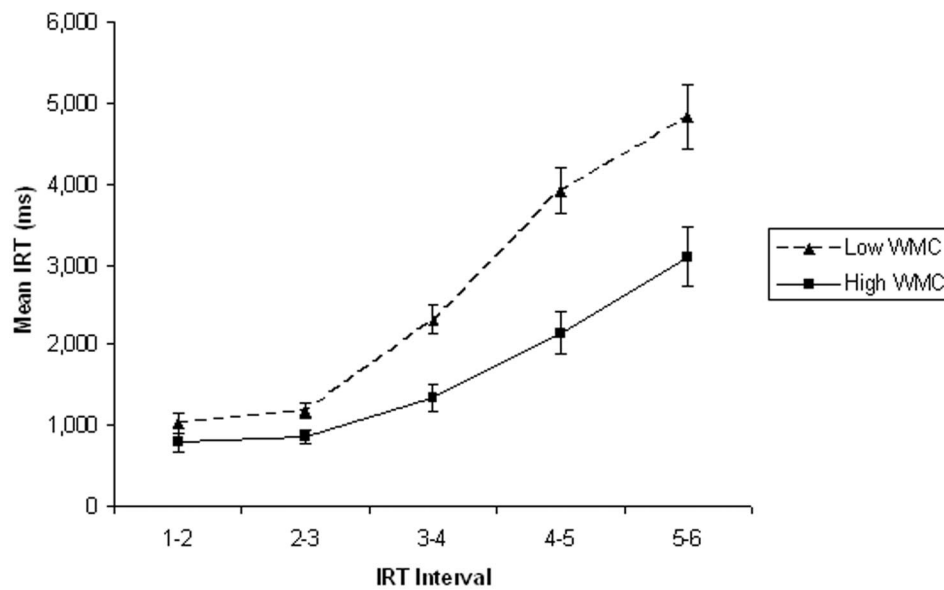

Figure 10. Interresponse times (IRTs) for the first six responses as a function of working memory capacity (WMC). Error bars represent one standard error of the mean.

cue-dependent search mechanism of SM. The model suggests that individual differences in WMC, as measured by complex span tasks, are due to an inability to distinctly maintain representations in PM and to effectively search for representations that have been displaced from PM into SM. Those individuals with lower WMCs are poorer at maintaining items in PM and are poorer at using cues to guide the search process of SM.

This framework represents a combination of our prior work arguing for the role of active maintenance in goal-directed behavior and some of our recent work arguing for the role of controlled search of memory when maintenance is impeded. Specifically, the current framework suggests that individual differences in WMC are related to individual differences in performance in basic attention tasks like antisaccade and Stroop because low WMC individuals are poorer at actively maintaining task goals in the face of internal and external distraction (Engle & Kane, 2004). When attention is captured by irrelevant stimuli, the task goals are no longer maintained in PM, and instead automatic responses guide behavior. Furthermore, in situations where information is lost from PM, because of the removal of attention, WMC is needed to guide a search process of SM to retrieve the information back into PM. This search process requires the use of precise temporal-contextual cues to discriminate between relevant and irrelevant information. The current framework suggests that low WMC individuals rely on noisier internally generated contextual cues and thus do not properly delimit their search sets to only the relevant information. Instead, low WMC individuals include irrelevant representations in their search sets. We argue that the simple notion of differences in the size of the search set can explain low WMC individuals' retrieval deficits in many tasks. This includes the complex span tasks themselves, as well as performance on delayed free recall tasks (Kane & Engle, 2000) and cued-recall tasks (Daniels, 2003; Rosen & Engle, 1998). Additionally, the notion of differences in the size of the search set coupled with dual-process models of recognition can explain why high and low WMC individuals differ only when recollection processes are required in interference-rich environments. In nearly all cases, low WMC individuals recall fewer items than high WMC individuals, recall more previous lists intrusions than high WMC individuals, and are slower to correctly recognize items than high WMC individuals.

We suggest that a dual-component model of some sort is needed to account for the current data and for individual differences in WMC. Specifically, the current results suggest that individual differences in WMC occur for both recency and pre-recency components of the serial position curve, but to different degrees. Additionally, as shown by Craik and Birtwistle (1971) and Davelaar et al. (2005), PI selectively disrupts retrieval for items from SM but not from PM, suggesting that items in PM have a protected status. Finally, the IRT analyses suggested that items unloaded from PM were emitted at a rapid pace, but that items retrieved from SM took much longer to be emitted. Together these results suggest that two components (active maintenance and controlled search) underlie performance on immediate free recall and are responsible for individual differences in WMC.

WMC and Higher Order Cognition

One of the biggest reasons WMC as a construct is thought to be so important is because over the past 25 years, tasks thought to tap

WMC have demonstrated an array of impressive correlations with many higher order constructs, including reading comprehension, fluid abilities, and learning to name a few. According to the view proposed here, low WMC individuals perform poorly on complex span and other memory tasks because they are unable to maintain information in PM and use internally generated cues to retrieve items that have been displaced from PM into SM. Furthermore, this ability to use cues to guide the search process of SM is an important reason why complex span tasks predict performance on measures of higher order cognition. For instance, consider a study by Cantor and Engle (1993) that examined how individual differences in WMC would covary with performance on the fact retrieval task discussed previously. Cantor and Engle found differential fan effects for high and low WMC participants similar to those found by Bunting et al. (2004). As fan size increased, low WMC individuals were much slower to retrieve information than high WMC individuals, even though both groups learned the information to the same levels initially. Of importance, Cantor and Engle found that the correlation between WMC and Verbal SAT scores was eliminated when the slope of the fan effect for each individual participant was partialled out. Specifically, the correlation between performance on a complex span task and performance on the Verbal SATs was .42. When the variance shared with the slope of each individual's fan effect was partialled out, the correlation dropped to .19. Thus, the ability to retrieve information in the presence of competing information differentiated high and low WMC participants and accounted for the covariation between WMC and Verbal SAT scores, illustrating the importance of cue-based retrieval. Additional support for this position comes from studies discussed previously that showed that WMC and resistance to interference are related. In several of these studies, measures of higher order cognition were included. For instance, in the error analysis of complex span tasks, we (Unsworth & Engle, 2006b) found that intrusion errors were significantly and uniquely related to a composite measure of fluid abilities. Furthermore, relying on estimates from Jacoby's (1991) process dissociation procedure, Daniels (2003) found that estimates of control in both verbal and spatial PI tasks not only were related to performance on complex span tasks, but were also related to performance on a measure of fluid abilities. Thus, it is becoming increasingly clear that one important reason measures of WMC correlate so well with measures of higher order cognition is because they provide an index of the ability to retrieve information in the presence of competition.

An important prediction of the framework advocated here is that reducing retrieval competition, by providing individuals with effective and appropriate cues, should reduce WMC differences and reduce the correlation between measures of WMC and higher order cognition. The study by Bunting (2006) that we discussed previously provides important evidence for this position. Recall that Bunting created three versions of the operation span task. The control version was a basic version of the operation span task. In a second version, Bunting manipulated the amount of interlist interference by having the to-be-remembered items switch from digits to words across lists. Like the procedure of Wickens, Born, and Allen (1963), this procedure should have allowed for a buildup and release of PI across lists. Finally, a third version manipulated intralist interference by having the to-be-remembered items switch from digits to words within a list (see also Young & Supa, 1941).

Thus, the two experimental versions of the operation span allowed for a reduction of retrieval competition by switching retrieval cues either across or within lists. Accordingly, this should have resulted in a higher probability of correctly recalling items and should have reduced the correlation between performance on the operation span and a measure of higher order cognition. This is exactly what occurred. Bunting found that probability correct was greater in the two experimental versions than in the control version, especially for those conditions where retrieval competition was reduced. Furthermore, Bunting found that the correlation between operation span and a measure of fluid abilities was reduced in those conditions where retrieval competition was reduced.

Work by Lustig, May, and Hasher (2001) supports this general finding. Lustig et al. found that reducing the buildup of PI in complex span tasks, by manipulating presentation order and inducing contextual changes between trials, resulted in higher span scores and reduced the correlation between complex span and a measure of higher order cognition (e.g., prose recall) to near zero. This provides supporting evidence that the ability to retrieve information in conditions where competition is high is an important contributor to performance on putative measures of WMC and their relation to higher order cognitive abilities. These results support the contention that one important aspect of WMC is the ability to retrieve items from SM in the presence of interference.

If this is true, then it is also important to demonstrate that such competition takes place in those measures of higher order cognition. That is, not only is the ability to retrieve information under conditions of interference important in the complex span tasks, but it is also important in higher order cognitive tasks like reading comprehension. For instance, several studies have shown that PI accrues in reading comprehension tasks (e.g., Blumenthal & Robbins, 1977; Dempster, 1985). In Dempster's (1985) study, participants were presented with several sentences from the same topic (e.g., anxiety) and then were switched to a new topic (e.g., hostility). Dempster hypothesized that PI would build for sentences from the same topic category and that there would then be a release from PI when the topic was switched. As expected, the functions closely resembled those examining PI in the Brown-Peterson task with probability correct decreasing over the first three trials and then rebounding for the switch trial. Furthermore, Dempster found that recall on Trial 1 was weakly related to subscores on the American College Test but that a measure of susceptibility to PI demonstrated much stronger correlations (although these results should be viewed with caution given that there were only 16 participants in the study). Thus, not only is PI susceptibility an important factor in memory tasks, but it is also important in higher order cognitive tasks, suggesting that the common variance shared between these tasks represents an ability to retrieve information in the presence of competition.

What Functions Are Spared for Low WMC Individuals?

Throughout the current article, we have tried to show that high and low WMC individuals do not differ on everything (as is sometimes assumed). There are situations where high and low WMC individuals perform equivalently and even some cases where low WMC individuals outperform high WMC individuals. For instance, as noted previously high and low WMC individuals do not differ on relatively automatic prosaccade trials, but when

prosaccades and antisaccades are mixed in the same block of trials, low WMC individuals are both slower and more error prone than high WMC individuals. Additionally, high and low WMC individuals do not differ on probe recognition tasks where responses can be guided by familiarity processes, but differences arise when recollection is needed, especially under conditions of interference. Finally, even when a controlled/strategic search of SM is required, in some situations low WMC individuals may actually be better at retrieving some information than high WMC individuals, as demonstrated in the directed forgetting. Thus, the claim that low WMC individuals are just poorer at all tasks is not warranted (see, e.g., Heitz, Schrock, Payne, & Engle, 2006, for an exploration of the role of extrinsic motivational differences). Rather, individual differences in WMC appear when information needs to be actively maintained in PM or needs to be retrieved from SM by means of a controlled cue-dependent search process. Listed in Table 4 are some of the tasks and/or variables that have been discussed previously as a function of whether they require active maintenance, controlled search, or neither. Note that some of these tasks likely require maintenance initially, but because of a distractor task, significant delay, or intervening items, search from SM is the more prominent function. As shown in Table 4, only in those situations where active maintenance or controlled search are theoretically required are individual differences in WMC found. In situations where active maintenance or controlled search are not required, no WMC differences are found.

In addition to the tasks/variables presented in Table 4, equivalent performance for high and low WMC individuals has been found in a number of other paradigms. For instance, a recent series of studies conducted by Kane, Poole, Tuholski and Engle (2006) demonstrated quite convincingly that there are clear boundary conditions for the construct of WMC. In these studies, Kane et al. examined high and low WMC individuals on a series of automatic and controlled visual search tasks. As noted previously, WMC differences should appear only when controlled processing is needed for accurate task performance, and no differences should be found in situations relying on more automatic processes. Consistent with this, Kane et al. found that high and low WMC individuals did not differ on fairly automatic pop-out searches. However, even on more controlled conjunctive searches, high and low WMC individuals performed equivalently. Thus, it is not the case that WMC differences appear in all conditions requiring some form of controlled processing. Rather, differences seem to appear only when active maintenance or controlled memory search is required. Note this does not mean that WMC differences always occur when recall is required. There are situations when high and low WMC individuals can recall information equivalently. This typically occurs when the information that needs to be recalled is well learned, as is the case with high-frequency vocabulary words and basic knowledge. Tests that tap vocabulary knowledge or general knowledge demonstrate either no correlation with measures of WMC or fairly weak correlations. For instance, a recent meta-analysis conducted by Ackerman, Beier, and Boyle (2005) found that a general knowledge component consisting of tests measuring science, mechanical, and electric knowledge demonstrated the weakest (although still significant) correlations with measures of WMC. Tirre and Pena (1992) also found weak correlations between a measure of WMC (reading span) and tests of knowledge verification ($r = .13$) and general science ($r = .10$)

Table 4
Breakdown of Situations Where Individual Differences in WMC Are Found on the Basis of the Theoretical Need for Either Active Maintenance in Primary Memory or Controlled Search in Secondary Memory

Task/variable	Maintenance in PM	Search in SM	WMC diff	Representative study
Complex span	yes	yes	+*	
Simple span	yes	yes	+	
Prosaccade blocked	no	no	=	Unsworth et al. (2004)
Prosaccade mixed	yes	no	+	Unsworth et al. (2004)
Antisaccade blocked	yes	no	+	Unsworth et al. (2004)
Antisaccade mixed	yes	no	+	Unsworth et al. (2004)
Stroop mostly incon	no	no	=	Kane and Engle (2003)
Stroop mostly con	yes	no	+	Kane and Engle (2003)
Brown–Peterson	no	yes	+	Kane and Engle (2000)
AB–AC paired associates	no	yes	+	Rosen and Engle (1998)
PDP control estimates	no	yes	+	Daniels (2003)
PDP automatic estimates	no	no	=	Daniels (2003)
Directed forgetting	no	yes	–	Delaney and Sahakyan (in press)
Recollection	no	yes	+	Oberauer (2005)
Familiarity	no	no	=	Oberauer (2005)
Recency IFR	yes	no	+	current
Prerecency IFR	no	yes	+	current

Note. See text for a discussion of these studies. An asterisk indicates a difference by definition; a plus sign indicates a positive correlation; a minus sign indicates a negative correlation; an equals sign indicates no correlation. PM = primary memory; SM = secondary memory; WMC = working memory capacity; diff = difference; Incon = incongruent; Con = congruent; PDP = process dissociation procedure; IFR = immediate free recall.

with a sample of 281 participants. Furthermore, in those studies that have accessed vocabulary abilities, measures of WMC have been found to be weakly correlated with vocabulary. For instance, in Ackerman et al. (2002), the average correlation for three common measures of WMC and a measure of vocabulary was .17 ($N = 135$). Additional weak correlations between measures of WMC and vocabulary have also been found by Tirre and Pena (1992; $r = .22$, $N = 281$); Baddeley, Logie, and Nimmo-Smith (1985, Experiment 2; mean $r = .14$, $N = 102$); and Honig (2005; mean $r = .07$, $N = 72$). Although clearly not an exhaustive listing, these correlations indicate that WMC is generally not related to the ability to recall highly learned information such as vocabulary terms or general knowledge.

This brief review highlights the fact that individual differences in WMC are not seen in all tasks and all situations. Rather, individual differences in WMC typically arise in situations where information needs to be actively maintained or when a controlled/strategic search of memory is required to retrieve task relevant information. Thus, WMC clearly demonstrates convergent validity in the sense that it is related to a number of theoretically important cognitive constructs, and it demonstrates divergent validity in the sense that it is not related to all cognitive constructs.

Before concluding this section, it is important to point out the possibility that some of the tasks listed here may not have enough discriminating power to detect differences between high and low WMC individuals (e.g., Baron & Treiman, 1980; Chapman & Chapman, 1973, 1978). That is, it is possible that low WMC individuals are in fact worse at everything, but those tasks where no differences are found simply are not difficult enough, are not reliable enough, or do not have enough variability to detect a true difference (e.g., Chapman & Chapman, 1973, 1978). Admittedly,

this notion of a generalized cognitive deficit cannot be ruled out entirely for every task that has been discussed here. However, as pointed out by Baron and Treiman (1980), a correlation analysis of the three variables in question (i.e., group, control task, and experimental task) can be informative. Specifically, Baron and Treiman have suggested that if the correlation between group membership and the experimental task is significantly higher than the correlation between group membership and the control task, then there is evidence for a differential deficit. For example, consider the finding of WMC differences in antisaccade conditions, but not in prosaccade conditions. Examining the correlation between WMC group and number of antisaccade errors from Unsworth et al. (2004, Experiment 1) suggests a reliable negative correlation ($r_{pb} = -.39$), whereas the correlation between WMC group and prosaccade errors was not reliable ($r_{pb} = -.11$). However, the correlation between prosaccade and antisaccade errors was reliable ($r = .36$). Using Williams's (1959) test for differences between nonindependent correlations suggests that the correlation between group membership and antisaccade errors is significantly higher than the correlation between prosaccade errors and group membership, $t(46) = 1.81$, $p < .05$ (one-tailed). Furthermore, the partial correlation between WMC group and antisaccade errors partialing out prosaccade errors remained largely unchanged ($pr_{pb} = -.38$), as did the correlation between WMC group and prosaccade errors partialing out antisaccade errors ($pr_{pb} = .04$) and the correlation between prosaccade and antisaccade errors partialing out WMC group ($pr_{pb} = .35$). Thus, although there were reliable individual differences in prosaccade errors, these differences were not related to differences in WMC. Differences in WMC were related to differences in antisaccade errors, but this variability was independent of the shared variability between pro-

saccade and antisaccade errors. This suggests that WMC differences that are found in the antisaccade task, but not in the prosaccade task, represent a true differential deficit and are not simply due to a lack of discrimination power.

WMC and Cognitive Neuroscience

The framework endorsed in this article has been influenced not only by cognitive theory, but also by work in cognitive neuroscience. In particular, as with some of our previous work, the current view suggests that the prefrontal cortex (PFC) is critically important for active maintenance of information in the face of internal and external distraction (e.g., Kane & Engle, 2002; see also Miller & Cohen, 2001). This work has suggested that the PFC is engaged in situations where information, particularly task goals, have to be maintained over some delay to guide ongoing processes. Furthermore, work in this line has suggested that the anterior cingulate cortex (ACC) is important for monitoring for the amount of control needed in a given task and biasing the PFC accordingly (e.g., Botvinick, Braver, Barch, Carter, & Cohen, 2001). Additionally, and consistent with work examining the role of the PFC in tasks thought to tap encoding and retrieval in SM, we suggest that the PFC is important for setting up retrieval cues and monitoring the products of retrieval (e.g., Simons & Spiers, 2003). Thus, the current view can be seen as an integration of our previous work arguing for the role of WMC in active maintenance (Engle & Kane, 2004) and our newer work arguing for the role of WMC in cue-dependent search (Unsworth & Engle, in press) with similar cognitive neuroscience views that emphasize the role of the PFC in active maintenance (e.g., Miller & Cohen, 2001) and the role of the PFC in controlled/strategic search (e.g., Moscovitch, 1992; Shimamura, 1995; Simons & Spiers, 2003). In these latter views, it is suggested that the PFC is important for cue-specification processes in which proper cues are set up to interrogate stored representations in the medial temporal lobes (MTL). Furthermore, the PFC (and possibly the ACC) is important to monitor the products of the retrieval processes from MTL. Thus, in a task like free recall, internally generated context cues are set up in the PFC, which then selectively interrogate representations stored in the MTL. Information retrieved from the MTL is then subjected to a monitoring process in the PFC according to some specified criterion. If the information meets the retrieval criterion, it is emitted.

These views, therefore, highlight the interaction of PFC and MTL processes to engage in a controlled/strategic search of memory. Indeed, several computational models have recently been developed to better examine the interaction of PFC and MTL processes in several memory tasks (e.g., Becker & Lim, 2003; Polyn, 2005; Polyn, Norman, & Cohen, 2003). A common characteristic of these models is that internally generated context cues in the PFC are used to examine representations stored in the MTL. For instance, in Polyn's model (Polyn, 2005; Polyn et al., 2003), the extent to which the retrieval process can be focused on target representations is directly related to the ability of the PFC to use the current contextual state as a cue. If the PFC component is lesioned, then the current contextual state activates too many representations stored in the MTL, leading to an inability to correctly recall the desired information. Thus, similar to the current view, this model suggests that what is critically important is the ability to focus the search on target representations through the

use of internally generated context cues. Furthermore, this ability is related to intact functioning of the PFC.

Assuming that individuals differ in the functioning of different neural systems, including the PFC, MTL, and ACC, we should see that some individuals are poorer at actively maintaining information or engaging in a controlled search of SM. We argue that it is these individuals we have labeled *low WMC* on the basis of their performance on complex memory span tasks. If this notion is correct, then we should see that not only are these areas engaged in complex memory span tasks (which are used to determine high and low WMC), but there is also a correlation between activity levels while performing the complex span tasks and performance on the complex span tasks. This is precisely the case. Several studies have shown that related to baseline conditions, the PFC and ACC are differently activated in several complex span tasks. For instance, relying on functional magnetic resonance imaging, Bunge, Klingberg, Jacobsen, and Gabrieli (2000) found strong PFC and ACC activations in a version of the reading span test. Similarly strong PFC activations were also found by Smith et al. (2001) using positron-emission tomography in a version of the operation span task.

Work by Osaka and colleagues (e.g., M. Osaka et al., 2003) has corroborated these basic findings and further extended them to better examine individual differences in WMC in a number of tasks. For instance, M. Osaka et al. (2003) examined performance in a version of the listening span task and found reliable activations in the PFC and ACC. Examining high and low WMC individuals, they found that compared with a baseline condition, ACC activation was significantly higher in high WMC individuals but not low WMC individuals. Similar results were found by Kondo, Morishita, et al. (2004) with a variant of the operation span task. Specifically, Kondo, Morishita, et al. found strong activations in the PFC and ACC during the operation span task and found stronger activations for high WMC individuals compared with low WMC individuals. Furthermore, relying on structural equation modeling, Kondo, Morishita, et al. found evidence for stronger connectivity between the PFC and the ACC in high WMC individuals compared with low WMC individuals. Likewise, in a spatial complex memory span task (i.e., rotation span; Kane et al., 2004; Shah & Miyake, 1996), Kondo, Osaka, and Osaka (2004) found stronger connectivity between the ACC and PFC in high WMC individuals compared with low WMC individuals. Collectively, these results suggest that those areas strongly implicated in the ability to actively maintain information and set up cues to search MTL structures (i.e., the PFC) and areas thought to be important in the ability to detect and modulate cognitive control (i.e., the ACC) are reliably active in measures of WMC and can potentially differentiate high from low WMC individuals.

Furthermore, one area in the PFC in particular seems to be important in those situations that tend to differentiate high from low WMC individuals: the inferior frontal gyrus (IFG). Several imaging and neuropsychological studies have suggested that the IFG is important in situations where specific representations have to be selected in the presence of multiple, highly interfering competitors. For instance, using an item recognition paradigm where previously relevant but now irrelevant items have to be rejected, several studies have shown that the IFG is reliably active (e.g., Jonides, Marshuetz, Smith, Reuter-Lorenz, & Koeppel, 2000; Jonides, Smith, Marshuetz, & Koeppel, 1998; Postle & Brush,

2004) on those trials exhibiting the highest amount of PI. Furthermore, neuropsychological investigations of the IFG have suggested that damage to this area results in exaggerated PI effects for both response time and accuracy (Thompson-Schill et al., 2002). Thus, the IFG seems critically important in those situations where a discrimination has to be made between relevant and irrelevant memory representations. As argued throughout this article, it is precisely these situations where individual differences in WMC are most pronounced. Accordingly, we might expect that individual differences in WMC would be related to functioning of the IFG in interference-rich situations such as complex memory span tasks. Indeed, in Bunge et al.'s (2000) study mentioned previously, the strongest activations were found in the IFG during the reading span task. Additionally, N. Osaka et al. (2004) found strong activation levels in the IFG during performance of a listening span task. Furthermore, N. Osaka et al. found that estimates of connectivity between the IFG and the ACC were higher in high WMC individuals than low WMC individuals. Thus, areas thought to be important in situations of high PI were reliably active in complex memory span tasks and were differently active in high and low WMC individuals (see also Mecklinger, Weber, Gunter, & Engle, 2003). These results support the overall notion that high and low WMC individuals differ primarily in those situations where relevant information has to be retrieved in the presence of strong competition. This ability to retrieve information in the presence of interference is linked to intact functioning of the IFG and possibly the ACC. These areas may be important in terms of detecting the presence of conflicting representations (ACC) and performing context discrimination at retrieval by setting up appropriate contextual cues to focus search in the MTL (e.g., Badre & Wagner, 2005; Bunge, Burrows, & Wagner, 2004). Furthermore, these same areas have also been implicated in individual differences in fluid abilities, especially in conditions of high interference (e.g., Gray, Chabris, & Braver, 2003). Thus, the same areas that demonstrate sensitivity to retrieval in the presence of interference also demonstrate sensitivity to individual differences in WMC and individual differences in fluid abilities.

Although clearly cursory, this review of relevant cognitive neuroscience studies suggests that active maintenance and controlled search processes rely on functioning of the PFC (particularly the IFG), the ACC, and the MTL. These same structures are also reliably active in complex memory span tasks and are linked to individual differences in WMC. Thus, individuals differ in the extent to which they can either actively maintain information or retrieve information, and these individual differences are linked to differences in neural functioning of the PFC, ACC, and MTL.

Relation to Other Work

The model we present here represents an amalgam of several different models. Consistent with many models, the current framework shares the notion that there is a highly activated subset of knowledge that is used for on-going processes (e.g., Anderson, 1983; Atkinson & Shiffrin, 1968; Cowan, 1988; Davelaar et al., 2005; Miller & Cohen, 2001; Norman, 1968; Shiffrin, 1976). Furthermore, this activated subset of information represents a fairly dynamic maintenance component that can change depending on the task goals (e.g., Atkinson & Shiffrin, 1968; Cowan, 2004; Davelaar et al., 2005; Speer, Jacoby, & Braver, 2003; Usher &

Cohen, 1999). In some situations it is important to maintain a single goal representation in the face of distraction (as in the antisaccade and Stroop tasks), yet in other situations it is important to maintain many representations in a heightened state of activity (as in list memory tasks). Similar to other theoretical views (e.g., Craik & Levy, 1976; Shiffrin, 1976), the current view suggests that information is actively maintained through the continued allocation of attention. When attention is allocated elsewhere, because of a voluntary or involuntary mechanism (e.g., Cowan, 1988), the current representations are no longer actively maintained. The current view is, therefore, consistent with many models of working memory that emphasize the importance of active maintenance in the service of task goals (e.g., Miyake & Shah, 1999). Furthermore, the current view is consistent with work suggesting that retrieval from secondary memory influences performances in working memory tasks (e.g., Hulme, Maughan, & Brown, 1991; Saint-Aubin & Poirier, 2000; Schweickert, 1993).

The current framework also highlights the importance of cue-dependent search to retrieve task relevant information (e.g., Davelaar et al., 2005; Nairne, 2002; Raaijmakers & Shiffrin, 1980; Shiffrin, 1970; Tulving, 1983). This cue-dependent search process is critically important in those situations where representations could not be maintained over extended time periods and/or in the face of potent distraction. The reliance of the current view on the notion of cue-dependent search being important in working memory is a novel departure from some other working memory models that rely exclusively on the notion of active maintenance. Important for this cue-dependent search approach is the idea that cues are used at the beginning of the retrieval phase to delimit the search set to only target representations (e.g., Shiffrin, 1970).

Important in this regard is the ability to use internally generated context cues to discriminate relevant versus irrelevant representations (Capaldi & Neath, 1995). The current view is, therefore, consistent with many models that highlight the importance of context cues (particularly temporal context) to guide retrieval (e.g., G. D. A. Brown et al., 2000; Capaldi & Neath, 1995; Estes, 1955; Glenberg, 1987; Glenberg et al., 1980, 1983; Howard & Kahana, 1999; Mensink & Raaijmakers, 1988). Note that the current view's reliance on cue-dependent retrieval is a departure from other views of working memory that suggest that decay is an important factor in forgetting (e.g., Baddeley, 1986). Similar to other models, the current view suggests that many of the effects taken as evidence for decay-based models of working memory (e.g., Baddeley, 1986) can be handled by cue-dependent retrieval frameworks (see, e.g., Nairne, 2002; Neath & Surprenant, 2003).

In many ways, the current framework can be seen as an incorporation of individual differences in WMC into more global models of memory that distinguish between two functional mechanisms (e.g., Davelaar et al., 2005; Raaijmakers & Shiffrin, 1980). Accordingly, this view suggests that traditional measures of WMC, such as complex spans, are not inherently special tasks, but rather can be interpreted in the same frameworks that are used to understand free and serial recall more broadly. In particular, those mechanisms that are used to understand immediate free recall can also be used to understand performance in complex memory span tasks. Thus, what is novel about the current approach is the notion that individual differences in WMC occur not only because of differences in active maintenance, but also because of differences in the ability to use cues to guide the search process from SM.

A primary alternative to the model we have presented here is a model advocating a unitary memory system (see Crowder, 1982; Nairne, 2002). In this view, all memory phenomena are due to the same underlying system, which relies on the effective use of memory cues to access items. Thus, in this view, there is no reason to distinguish between PM and SM systems. Rather, items are remembered or forgotten on the basis of the cues that are used to access the items. An item is associated with a high probability of recall if the cues used to access the item uniquely specify only that item. Some items (recency items) have a higher probability of recall not because they sit in special short-term store, but because these items are more distinct because of temporal-contextual distinctiveness (e.g., Glenberg & Swanson, 1986). Accordingly, a unitary memory model argues that memory over both the short- and long-term is determined by retrieval rules and use of retrieval cues to access items.

Despite the similarity of our model and a unitary memory model in terms of using cues to access items, we still maintain that a maintenance buffer of some sort is needed. A number of reviews over the years have argued for the heuristic value of dual-store models in general (e.g., Healy & McNamara, 1996; Raaijmakers, 1993; Shiffrin, 1993). However, an equal number of reviews have argued for a unitary memory model (e.g., Crowder, 1982, 1989, 1993; Nairne, 2002). Note that although Crowder (1989) acknowledged the possibility of a short-term buffer that can maintain two or three items, he suggested that this is such a miniscule capacity limit that it would not aid in performance on a number of cognitive tasks. However, as noted previously, we suggest that maintaining only one representation (i.e., a goal representation) in PM can be the difference between successful and unsuccessful performance in some tasks.

In discussing the reasons to prefer a unitary memory system over a dual memory system, Crowder (1982, 1989, 1993) argued that two primary pieces of evidence for dual-store models, Brown-Peterson forgetting and recency effects in free recall, could easily be accounted for by a unitary memory model. Specifically, Crowder argued that forgetting in the Brown-Peterson task was more easily handled by a unitary memory system that relied on contextual cues than by a dual-store model. Crowder suggested that a short-term buffer was not needed to account for forgetting in this and similar paradigms and thus a unitary memory model is to be preferred. However, more recent versions of the dual-store model are actually in agreement with Crowder's position. Specifically, the distractor activity in the Brown-Peterson task should displace items from PM and thus these items would have to be recalled from SM by means of contextual cues (see Davelaar & Usher, 2002, for a dual-store model of this task). Thus, like delayed free recall, items are displaced from PM in the Brown-Peterson task, and correct recall is contingent on accurate retrieval from SM.

The second piece of evidence that Crowder (1982, 1993) used to argue against a dual-store model was the finding of a long-term recency effect (Bjork & Whitten, 1974). In the continuous distractor task, to-be-remembered items are interleaved with some form of processing task. Because the processing task should theoretically displace all items from the buffer (see earlier discussion), recency effects should not be found. However, recency effects are routinely found in the continuous distractor task. Accordingly, Crowder and others have suggested that a buffer model cannot account for long-term recency effects. Dual-store theorists have

refuted this argument on the basis of the fact that not all recency effects need to be based on the same mechanism, and thus recency effects in immediate free recall and continuous distractor free recall are not necessarily the same (e.g., Raaijmakers, 1993). Indeed, the primary thesis of Davelaar et al. (2005) is that recency in immediate free recall is based on unloading from a buffer and recency in continuous distractor free recall is based on the use of context cues. In support of this, Davelaar et al. provided a number of important pieces of evidence suggesting a dissociation between the two recency effects. Thus, evidence against dual-component models may not be as strong as it once was.

Concluding Remarks

In this article, we have advanced the view that individual differences in WMC can be interpreted in terms of a dual-component framework. Representations are either maintained in PM through the continued allocation of attention or are retrieved through a cue-dependent search process from SM. Individual differences in WMC can occur either because of the efficiency of using PM or because of the efficiency of using cues to guide the search process of SM. An unresolved issue is the extent to which these two components are independent or whether they rely on a more general mechanism. For instance, estimates of PM and SM (obtained from immediate free recall) have been shown to load on separate and nearly uncorrelated factors (Carroll, 1993), suggesting that the two components are independent. It should be noted, however, that it is possible that other measures of these constructs will demonstrate relations with one another. Thus, future research should be devoted to exploring the independence of these two components.

An additional issue is that the view we have presented here is a rather simplistic view of how the memory system works. At a surface level, it suggests a fairly static system in which items are either in PM or in SM. In reality, a much more dynamic system is more appropriate. Items are continually being displaced from PM and are retrieved from SM into PM, and numerous updating and manipulations of representations are occurring. Thus, the view that items in complex span tasks are being retrieved from SM because the processing component displaces them from PM is an overly simplistic description of the actual processes that are occurring. It is more likely that items are being displaced from PM and that some of the items are being recycled back into PM by means of retrieval from SM (e.g., Barrouillet, Bernardin, & Camos, 2004). However, the overall framework is useful in interpreting individual differences in WMC in a wide array of tasks and situations.

Furthermore, the model we have outlined here is clearly descriptive and lacks the quantitative rigor of some of the models on which it is based (e.g., Davelaar et al., 2005; Raaijmakers & Shiffrin, 1980, 1981; Shiffrin, 1970). We have attempted to present a fairly general view of memory and attention that examines various indexes of performance on some common memory tasks with an incorporation of individual differences. It is beyond the scope of this article to provide a detailed quantitative model based on the descriptive framework we have presented here and to apply it to the data. However, it is possible that the framework here could be implemented in existing quantitative models, such as the search of associative memory model (Raaijmakers & Shiffrin, 1980, 1981) or the context-activation model of Davelaar et al.

(2005), with a few minor variations. Future work should be directed at incorporating individual differences into formal models to better account for the existing data.

Finally, in this article we have tried to advocate the benefits of a combined experimental and differential program of research (e.g., Cohen, 1994; Cronbach, 1957; Underwood, 1975). Examining basic memory and attention processes in terms of individual differences provides valuable information about how performance differs among individuals and how this variability might covary with performance in other cognitive domains. We hope that the ideas presented in this article will promote a more detailed consideration of individual differences in attention and memory processes and their relation to higher order cognition.

References

- Ackerman, P. L., Beier, M. E., & Boyle, M. O. (2002). Individual differences in working memory within a nomological network of cognitive and perceptual speed abilities. *Journal of Experimental Psychology: General*, *131*, 567–589.
- Ackerman, P. L., Beier, M. E., & Boyle, M. O. (2005). Working memory and intelligence: The same or different constructs? *Psychological Bulletin*, *131*, 30–60.
- Anderson, J. R. (1974). Retrieval of propositional information from long-term memory. *Cognitive Psychology*, *6*, 451–474.
- Anderson, J. R. (1983). *The architecture of cognition*. Cambridge, MA: Harvard University Press.
- Atkinson, R. C., & Shiffrin, R. M. (1968). Human memory: A proposed system and its control processes. In K. W. Spence (Ed.), *The psychology of learning and motivation* (Vol. 2, pp. 89–195). New York: Academic Press.
- Atkinson, R. C., & Shiffrin, R. M. (1971). The control of short-term memory. *Scientific American*, *225*, 82–90.
- Baddeley, A. D. (1986). *Working memory*. London: Oxford University Press.
- Baddeley, A. D. (2000). The episodic buffer: A new component of working memory? *Trends in Cognitive Sciences*, *4*, 417–423.
- Baddeley, A. D., & Hitch, G. (1974). Working memory. In G. H. Bower (Ed.), *The psychology of learning and motivation* (Vol. 8, pp. 47–89). New York: Academic Press.
- Baddeley, A. D., Logie, R., & Nimmo-Smith, I. (1985). Components of fluent reading. *Journal Memory and Language*, *24*, 119–131.
- Badre, D., & Wagner, A. D. (2005). Frontal lobe mechanisms that resolve proactive interference. *Cerebral Cortex*, *15*, 2003–2012.
- Baron, J., & Treiman, R. (1980). Some problems in the study of differences in cognitive processes. *Memory & Cognition*, *8*, 313–321.
- Barrouillet, P., Bernardin, S., & Camos, V. (2004). Time constraints and resource sharing in adults' working memory spans. *Journal of Experimental Psychology: General*, *133*, 83–100.
- Becker, S., & Lim, J. (2003). A computational model of prefrontal control in free recall: Strategic memory use in the California Verbal Learning Task. *Journal of Cognitive Neuroscience*, *15*, 821–832.
- Bennett, R. W. (1975). Proactive interference in short-term memory: Fundamental forgetting processes. *Journal of Verbal Learning and Verbal Behavior*, *14*, 123–144.
- Bjork, R. A., & Whitten, W. B. (1974). Recency-sensitive retrieval processes in long-term free recall. *Cognitive Psychology*, *6*, 173–189.
- Blankenship, A. B. (1938). Memory span: A review of the literature. *Psychological Bulletin*, *35*, 1–35.
- Blumenthal, G. B., & Robbins, D. (1977). Delayed release from proactive interference with meaningful material: How much do we remember after reading a brief prose passage? *Journal of Experimental Psychology: Human Learning and Memory*, *3*, 754–761.
- Botvinick, M. M., Braver, T. S., Barch, D. M., Carter, C. S., Cohen, J. D. (2001). Conflict monitoring and cognitive control. *Psychological Review*, *108*, 624–652.
- Bousfield, W. A., Sedgewick, C. H. W., & Cohen, B. H. (1954). Certain temporal characteristics of the recall of verbal associates. *American Journal of Psychology*, *67*, 111–118.
- Bowles, R. P., & Salthouse, T. A. (2003). Assessing the age-related effects of proactive interference on working memory tasks using the Rasch model. *Psychology and Aging*, *18*, 608–615.
- Broadbent, D. E. (1975). The magic number seven after fifteen years. In R. A. Kennedy & A. Wilkes (Eds.), *Studies in long-term memory* (pp. 3–18). New York: Wiley.
- Brown, G. D. A., Preece, T., & Hulme, C. (2000). Oscillator-based memory for serial order. *Psychological Review*, *107*, 127–181.
- Brown, J. (1958). Some tests of the decay theory of immediate memory. *Quarterly Journal of Experimental Psychology*, *10*, 12–21.
- Bunge, S. A., Burrows, B., & Wagner, A. D. (2004). Prefrontal and hippocampal contributions to visual associative recognition: Interactions between cognitive control and episodic retrieval. *Brain and Cognition*, *56*, 141–152.
- Bunge, S. A., Klingberg, T., Jacobsen, R. B., & Gabrieli, J. D. E. (2000). A resource model of the neural basis of executive working memory. *Proceedings of the National Academy of Sciences*, *97*, 3573–3578.
- Bunting, M. F. (2006). Proactive interference and item similarity in working memory. *Journal of Experimental Psychology: Learning, Memory, and Cognition*, *32*, 183–196.
- Bunting, M. F., Conway, A. R. A., & Heitz, R. P. (2004). Individual differences in the fan effect and working memory capacity. *Journal of Memory and Language*, *51*, 604–622.
- Cantor, J., & Engle, R. W. (1993). Working memory capacity as long-term memory activation: An individual differences approach. *Journal of Experimental Psychology: Learning, Memory, and Cognition*, *19*, 1101–1114.
- Capaldi, E. J., & Neath, I. (1995). Remembering and forgetting as context discrimination. *Learning & Memory*, *2*, 107–132.
- Carroll, J. B. (1993). *Human cognitive abilities: A survey of factor-analytic studies*. New York: Cambridge University Press.
- Chapman, L. J., & Chapman, J. P. (1973). Problems in the measurement of cognitive deficit. *Psychological Bulletin*, *79*, 380–385.
- Chapman, L. J., & Chapman, J. P. (1978). The measurement of differential deficit. *Journal of Psychiatric Research*, *14*, 303–311.
- Cohen, R. L. (1994). Some thoughts on individual differences and theory construction. *Intelligence*, *18*, 3–13.
- Conway, A. R. A., Cowan, N., & Bunting, M. F. (2001). The cocktail party phenomenon revisited: The importance of working memory capacity. *Psychonomic Bulletin & Review*, *8*, 331–335.
- Conway, A. R. A., Cowan, N., Bunting, M. F., Theriault, D. J., & Minkoff, S. R. B. (2002). A latent variable analysis of working memory capacity, short-term memory capacity, processing speed, and general fluid intelligence. *Intelligence*, *30*, 163–183.
- Conway, A. R. A., & Engle, R. W. (1994). Working memory and retrieval: A resource-dependent inhibition model. *Journal of Experimental Psychology: General*, *123*, 354–373.
- Cowan, N. (1988). Evolving conceptions of memory storage, selective attention, and their mutual constraints within the human information processing system. *Psychological Bulletin*, *104*, 163–191.
- Cowan, N. (1992). Verbal memory span and the timing of spoken recall. *Journal of Memory and Language*, *31*, 668–684.
- Cowan, N. (1995). *Attention and memory: An integrated framework*. Oxford, England: Oxford University Press.
- Cowan, N. (2001). The magical number 4 in short-term memory: A reconsideration of mental storage capacity. *Behavioral and Brain Sciences*, *24*, 97–185.
- Cowan, N. (2004). Understanding intelligence: A summary and an

- adjustable-attention hypothesis. In O. Wilhelm & R. W. Engle (Eds.), *Understanding and measuring intelligence* (pp. 469–488). New York: Sage.
- Cowan, N., Johnson, T. D., & Saults, J. S. (2005). Capacity limits in list item recognition: Evidence from proactive interference. *Memory, 13*, 293–299.
- Cowan, N., Towse, J. N., Hamilton, Z., Saults, J. S., Elliot, E. M., Lacey, J. F., et al. (2003). Children's working-memory processes: A response-timing analysis. *Journal of Experimental Psychology: General, 132*, 113–132.
- Cowan, N., Wood, N. L., Wood, P. K., Keller, T. A., Nugent, L. D., & Keller, C. V. (1998). Two separate verbal processing rates contributing to short-term-memory span. *Journal of Experimental Psychology: General, 127*, 141–160.
- Craik, F. I. M. (1971). Primary memory. *British Medical Bulletin, 27*, 232–236.
- Craik, F. I. M., & Birtwistle, J. (1971). Proactive inhibition in free recall. *Journal of Experimental Psychology, 91*, 120–123.
- Craik, F. I. M., & Levy, B. A. (1976). The concept of primary memory. In W. K. Estes (Ed.), *Handbook of learning and cognitive processes* (pp. 133–175). New York: Erlbaum.
- Cronbach, L. J. (1957). The two disciplines of scientific psychology. *American Psychologist, 12*, 671–684.
- Crowder, R. G. (1982). The demise of short-term memory. *Acta Psychologica, 50*, 291–323.
- Crowder, R. G. (1989). Modularity and dissociations in memory systems. In H. L. Roediger III & F. I. M. Craik (Eds.), *Varieties of memory and consciousness: Essays in honor of Endel Tulving* (pp. 271–294). Hillsdale, NJ: Erlbaum.
- Crowder, R. G. (1993). Short-term memory: Where do we stand? *Memory & Cognition, 21*, 142–145.
- Daneman, M., & Carpenter, P. A. (1980). Individual differences in working memory and reading. *Journal of Verbal Learning and Verbal Behavior, 19*, 450–466.
- Daneman, M., & Green, I. (1986). Individual differences in comprehending and producing words in context. *Journal of Memory and Language, 25*, 1–18.
- Daniels, K. A. (2003). *Control, automaticity, and working memory: A dual-process analysis*. Unpublished doctoral dissertation, Georgia Institute of Technology.
- Davelaar, E. J., Goshen-Gottstein, Y., Ashkenazi, A., Haarmann, H. J., & Usher, M. (2005). The demise of short-term memory revisited: Empirical and computational investigations of recency effects. *Psychological Review, 112*, 3–42.
- Davelaar, E. J., & Usher, M. (2002). An activation-based theory of immediate item memory. In J. A. Bullinaria & W. Lowe (Eds.), *Proceedings of the Seventh Neural Computation and Psychology Workshop: Connectionist models of cognition and perception* (pp. 118–130). Singapore, World Scientific.
- Delaney, P. F., & Sahakyan, L. (in press). Unexpected costs of high working memory capacity following directed forgetting and contextual change manipulations. *Memory & Cognition*.
- Dempster, F. N. (1985). Proactive interference in sentence recall: Topic-similarity effects and individual differences. *Memory & Cognition, 13*, 81–89.
- Dempster, F. N., & Cooney, J. B. (1982). Individual differences in memory span, susceptibility to proactive interference, and aptitude/achievement test scores. *Intelligence, 6*, 399–416.
- Ebbinghaus, H. (1964). *Memory: A contribution to experimental psychology* (H. A. Ruger & C. E. Bussenius, Trans.). New York: Dover. (Original work published 1885)
- Engle, R. W., & Kane, M. J. (2004). Executive attention, working memory capacity, and a two-factor theory of cognitive control. In B. Ross (Ed.), *The psychology of learning and motivation* (Vol. 44, pp. 145–199). New York: Elsevier.
- Engle, R. W., Tuoholski, S. W., Laughlin, J. E., & Conway, A. R. A. (1999). Working memory, short-term memory and general fluid intelligence: A latent-variable approach. *Journal of Experimental Psychology: General, 128*, 309–331.
- Estes, W. K. (1955). Statistical theory of spontaneous recovery and regression. *Psychological Review, 62*, 145–154.
- Friedman, N. P., & Miyake, A. (2004). The relations among inhibition and interference control functions: A latent-variable analysis. *Journal of Experimental Psychology: General, 133*, 101–135.
- Gardiner, J. M., Craik, F. I. M., & Birtwistle, J. (1972). Retrieval cues and release from proactive inhibition. *Journal of Verbal Learning and Verbal Behavior, 11*, 778–783.
- Glanzer, M. (1972). Storage mechanisms in recall. In G. H. Bower & J. T. Spence (Eds.), *The psychology of learning and motivation* (Vol. 5, pp. 129–193). New York: Academic Press.
- Glanzer, M., & Cunitz, A. R. (1966). Two storage mechanisms in free recall. *Journal of Verbal Learning and Verbal Behavior, 5*, 351–360.
- Glenberg, A. M. (1987). Temporal context and recency. In D. S. Gorfein & R. R. Hoffman (Eds.), *Memory and learning: The Ebbinghaus centennial conference* (pp. 173–190). Hillsdale, NJ: Erlbaum.
- Glenberg, A. M., Bradley, M. M., Stevenson, J. A., Kraus, T. A., & Renzaglia, G. J. (1983). Studies of the long-term recency effect: Support for a contextually guided retrieval hypothesis. *Journal of Experimental Psychology: Human Learning and Memory, 9*, 231–255.
- Glenberg, A. M., Bradley, M. M., Stevenson, J. A., Kraus, T. A., Tkachuk, M. J., Gretz, A. L., et al. (1980). A two-process account of long-term serial position effects. *Journal of Experimental Psychology: Human Learning and Memory, 6*, 355–369.
- Glenberg, A. M., & Swanson, N. G. (1986). A temporal distinctiveness theory of recency and modality effects. *Journal of Experimental Psychology: Learning, Memory, and Cognition, 12*, 3–15.
- Gray, J. R., Chabris, C. F., & Braver, T. S. (2003). Neural mechanisms of general fluid intelligence. *Nature Neuroscience, 6*, 316–322.
- Haarmann, H. J., & Usher, M. (2001). Maintenance of semantic information in capacity-limited item short-term memory. *Psychonomic Bulletin & Review, 8*, 568–578.
- Halford, G. S., Mayberry, M. T., & Bain, J. D. (1988). Set-size effects in primary memory. An age related capacity limitation? *Memory & Cognition, 16*, 480–487.
- Hallet, P. E. (1978). Primary and secondary saccades to goals defined by instructions. *Vision Research, 18*, 1279–1296.
- Healy, A. F., & McNamara, D. S. (1996). Verbal learning and memory: Does the modal model still work? *Annual Review of Psychology, 47*, 143–172.
- Heitz, R. P., & Engle, R. W. (in press). Focusing the spotlight: Individual differences in visual attention control. *Journal of Experimental Psychology: General*.
- Heitz, R. P., Schrock, J. C., Payne, T. W., & Engle, R. W. (2006). *Effects of incentive on working memory capacity: Behavioral and pupillometric data*. Manuscript submitted for publication.
- Honig, R. M. (2005). *Central executive processing: Mother, daughter, or sister of suppression? A study of reading comprehension ability*. Unpublished doctoral dissertation, University of Texas at Austin.
- Howard, M. W., & Kahana, M. J. (1999). Contextual variability and serial position effects in free recall. *Journal of Experimental Psychology: Learning, Memory, and Cognition, 25*, 923–941.
- Hulme, C., Maughan, S., & Brown, G. D. A. (1991). Memory for familiar and unfamiliar words: Evidence for long-term memory contributions to short-term memory span. *Journal of Memory and Language, 30*, 685–701.
- Indow, T., & Togano, K. (1970). On retrieving sequences from long-term memory. *Psychological Review, 77*, 317–331.

- Jacobs, J. (1887). Experiments on "prehension." *Mind*, *12*, 75–79.
- Jacoby, L. L. (1991). A process-dissociation framework: Separating automatic from intentional uses of memory. *Journal of Memory and Language*, *30*, 513–541.
- Jacoby, L. L., Debner, J. A., & Hay, J. F. (2001). Proactive interference, accessibility bias, and process dissociation: Valid subject reports of memory. *Journal of Experimental Psychology: Learning, Memory, and Cognition*, *27*, 686–700.
- James, W. (1890). *Principles of psychology*. New York: Holt.
- Jonides, J., Marshuetz, C., Smith, E. E., Reuter-Lorenz, P. A., & Koeppel, R. A. (2000). Age differences in behavior and PET activation reveal differences in interference resolution in verbal working memory. *Journal of Cognitive Neuroscience*, *12*, 188–196.
- Jonides, J., Smith, E. E., Marshuetz, C., & Koeppel, R. A. (1998). Inhibition in verbal-working memory revealed by brain activation. *Proceedings of the National Academy of Sciences*, *95*, 8410–8413.
- Kane, M. J., Bleckley, M. K., Conway, A. R. A., & Engle, R. W. (2001). A controlled-attention view of working-memory capacity. *Journal of Experimental Psychology: General*, *130*, 169–183.
- Kane, M. J., & Engle, R. W. (2000). Working memory capacity, proactive interference, and divided attention: Limits on long-term retrieval. *Journal of Experimental Psychology: Learning, Memory, and Cognition*, *26*, 333–358.
- Kane, M. J., & Engle, R. W. (2002). The role of prefrontal cortex in working-memory capacity, executive attention, and general fluid intelligence: An individual differences perspective. *Psychonomic Bulletin and Review*, *9*, 637–671.
- Kane, M. J., & Engle, R. W. (2003). Working-memory capacity and the control of attention: The contributions of goal neglect, response competition, and task set to Stroop interference. *Journal of Experimental Psychology: General*, *132*, 47–70.
- Kane, M. J., Hambrick, D. Z., Tuholski, S. W., Wilhelm, O., Payne, T. W., & Engle, R. W. (2004). The generality of working-memory capacity: A latent-variable approach to verbal and visuo-spatial memory span and reasoning. *Journal of Experimental Psychology: General*, *133*, 189–217.
- Kane, M. J., Poole, B. J., Tuholski, S. W., & Engle, R. W. (2006). Working memory capacity and the top-down control of visual search: Exploring the boundaries of "executive attention." *Journal of Experimental Psychology: Learning, Memory, and Cognition*, *32*, 749–777.
- Kaplan, I. T., Carvellas, T., & Metlay, W. (1969). Searching for words in letter sets of varying size. *Journal of Experimental Psychology*, *82*, 377–380.
- Kline, R. B. (1998). *Principles and practice of structural equation modeling*. New York: Guilford Press.
- Kondo, H., Morishita, M., Osaka, N., Osaka, M., Fukuyama, H., & Shibasaki, H. (2004). Functional roles of the cingulo-frontal network in performance on working memory. *NeuroImage*, *21*, 2–14.
- Kondo, H., Osaka, N., & Osaka, M. (2004). Cooperation of the anterior cingulate cortex and dorsolateral prefrontal cortex for attention shifting. *NeuroImage*, *23*, 670–679.
- Kyllonen, P. C., & Christal, R. E. (1990). Reasoning ability is (little more than) working-memory capacity? *Intelligence*, *14*, 389–433.
- Kyllonen, P. C., & Stephens, D. L. (1990). Cognitive abilities as determinants of success in acquiring logic skill. *Learning and Individual Differences*, *2*, 129–160.
- Lee, C. L., & Estes, W. K. (1981). Item and order information in short-term memory: Evidence for multilevel perturbation processes. *Journal of Experimental Psychology: Human Learning and Memory*, *7*, 149–169.
- Long, D. L., & Prat, C. S. (2002). Working memory and Stroop interference: An individual differences investigation. *Memory & Cognition*, *30*, 294–301.
- Lustig, C., May, C. P., & Hasher, L. (2001). Working memory span and the role of proactive interference. *Journal of Experimental Psychology: General*, *130*, 199–207.
- May, C. P., Hasher, L., & Kane, M. J. (1999). The role of interference in memory span. *Memory & Cognition*, *27*, 759–767.
- McGill, W. J. (1963). Stochastic latency mechanism. In R. D. Luce, R. R. Bush, & E. Galanter (Eds.), *Handbook of mathematical psychology* (Vol. 1, pp. 309–360). New York: Wiley.
- Mecklinger, A., Weber, K., Gunter, T. C., & Engle, R. W. (2003). Dissociable brain mechanisms for inhibitory control: Effects of interference content and working memory capacity. *Cognitive Brain Research*, *18*, 28–38.
- Mensink, G., & Raaijmakers, J. G. W. (1988). A model for interference and forgetting. *Psychological Review*, *95*, 434–455.
- Metcalfe, J., & Murdock, B. B. (1981). An encoding and retrieval model in single trial free recall. *Journal of Verbal Learning and Verbal Behavior*, *20*, 161–189.
- Miller, E. K., & Cohen, J. D. (2001). An integrative theory of prefrontal cortex functioning. *Annual Review of Neuroscience*, *24*, 167–202.
- Miyake, A., & Shah, P. (Eds.). (1999). *Models of working memory: Mechanisms of active maintenance and executive control*. New York: Cambridge University Press.
- Moscovitch, M. (1992). Memory and working with memory: A component process model based on modules and central systems. *Journal of Cognitive Neuroscience*, *4*, 257–267.
- Murdock, B. B. (1962). The serial position effect of free recall. *Journal of Verbal Learning and Verbal Behavior*, *64*, 482–488.
- Murdock, B. B., & Okada, R. (1970). Interresponse times in single-trial free recall. *Journal of Experimental Psychology*, *86*, 263–267.
- Nairne, J. S. (2002). Remembering over the short-term: The case against the standard model. *Annual Review of Psychology*, *53*, 53–81.
- Neath, I., & Surprenant, A. M. (2003). *Human memory: An introduction to research, data, and theory* (2nd ed.). Belmont, CA: Wadsworth.
- Nilsson, L.-G., Wright, E., & Murdock, B. B. (1975). The effects of visual presentation method on single-trial free recall. *Memory & Cognition*, *3*, 427–433.
- Norman, D. A. (1968). Toward a theory of memory and attention. *Psychological Review*, *75*, 522–536.
- Oberauer, K. (2002). Access to information in working memory: Exploring the focus of attention. *Journal of Experimental Psychology: Learning, Memory, and Cognition*, *28*, 411–421.
- Oberauer, K. (2005). Binding and inhibition in working memory: Individual and age differences in short-term recognition. *Journal of Experimental Psychology: General*, *134*, 368–387.
- Oberauer, K., Süb, H.-M., Schulze, R., Wilhelm, O., & Wittmann, W. W. (2000). Working memory capacity—facets of a cognitive ability construct. *Personality & Individual Differences*, *29*, 1017–1045.
- Osaka, M., Osaka, N., Kondo, H., Morishita, M., Fukuyama, H., Aso, T., & Shibasaki, H. (2003). The neural basis of individual differences in working memory capacity: An fMRI study. *NeuroImage*, *18*, 789–797.
- Osaka, N., Osaka, M., Kondo, H., Morishita, M., Fukuyama, H., & Shibasaki, H. (2004). The neural basis of executive function in working memory: An fMRI study based on individual differences. *NeuroImage*, *21*, 623–631.
- Peterson, L. R., & Peterson, M. J. (1959). Short-term retention of individual verbal items. *Journal of Experimental Psychology*, *58*, 193–198.
- Polyn, S. M. (2005). *Neuroimaging, behavioral, and computational investigations of memory targeting*. Unpublished doctoral dissertation, Princeton University, New Jersey.
- Polyn, S. M., Norman, K. A., & Cohen, J. D. (2003, April). *Modeling prefrontal and medial temporal contributions to episodic memory*. Paper presented at the annual meeting of the Cognitive Neuroscience Society, New York.

- Posner, M. I., & Snyder, C. R. R. (1975). Attention and cognitive control. In R. Solso (Ed.), *Information processing & cognition: The Loyola symposia* (pp. 55–85). Hillsdale, NJ: Erlbaum.
- Postle, B. R., & Brush, L. N. (2004). The neural bases of the effects of item-nonspecific proactive interference in working memory. *Cognitive, Affective, & Behavioral Neuroscience*, 4, 379–392.
- Postman, L., & Phillips, L. W. (1965). Short-term temporal changes in free recall. *Quarterly Journal of Experimental Psychology*, 17, 132–138.
- Raaijmakers, J. G. W. (1993). The story of the two-store model in memory: Past criticisms, current status, and future directions. In D. E. Meyer & S. Kornblum (Eds.), *Attention and performance XIV: Synergies in experimental psychology, artificial intelligence, and cognitive neuroscience*. (pp. 467–488). Cambridge, MA: MIT Press.
- Raaijmakers, J. G. W., & Shiffrin, R. M. (1980). SAM: A theory of probabilistic search of associative memory. In G. Bower (Ed.), *The psychology of learning and motivation* (Vol. 14, pp. 207–262). New York: Academic Press.
- Raaijmakers, J. G. W., & Shiffrin, R. M. (1981). Search of associative memory. *Psychological Review*, 88, 93–134.
- Roberts, R. J., Hager, L. D., & Heron, C. (1994). Prefrontal cognitive processes: Working memory and inhibition in the antisaccade task. *Journal of Experimental Psychology: General*, 123, 374–393.
- Roberts, R. J., & Pennington, B. F. (1996). An integrative framework for examining prefrontal cognitive processes. *Developmental Neuropsychology*, 12(1), 105–126.
- Roediger, H. L., III, Stellan, C. C., & Tulving, E. (1977). Inhibition from part-list cues and rate of recall. *Journal of Experimental Psychology: Human Learning & Memory*, 3, 174–188.
- Rohrer, D. (1996). On the relative and absolute strength of a memory trace. *Memory & Cognition*, 24, 188–201.
- Rohrer, D. (2002). The breadth of memory search. *Memory*, 10, 291–301.
- Rohrer, D., & Wixted, J. T. (1994). An analysis of latency and interresponse time in free recall. *Memory & Cognition*, 22, 511–524.
- Rosen, V. M., & Engle, R. W. (1997). The role of working memory capacity in retrieval. *Journal of Experimental Psychology: General*, 126, 211–227.
- Rosen, V. M., & Engle, R. W. (1998). Working memory capacity and suppression. *Journal of Memory and Language*, 39, 418–436.
- Sahakyan, L., & Kelley, C. M. (2002). A contextual change account of the directed forgetting effect. *Journal of Experimental Psychology: Learning, Memory, and Cognition*, 28, 1064–1072.
- Saint-Aubin, J., & Poirier, M. (2000). Immediate serial recall of words and non-words: A test of the retrieval-based hypothesis. *Psychonomic Bulletin and Review*, 7, 332–340.
- Schneider, W., & Shiffrin, R. M. (1977). Controlled and automatic human information processing I: Detection, search, and attention. *Psychological Review*, 84, 1–66.
- Schweickert, R. (1993). A multinomial processing tree model for degradation and redintegration in immediate recall. *Memory & Cognition*, 21, 168–175.
- Shah, P., & Miyake, A. (1996). The separability of working memory resources for spatial thinking and language processing: An individual differences approach. *Journal of Experimental Psychology: General*, 125, 4–27.
- Shiffrin, R. M. (1970). Memory search. In D. A. Norman (Ed.), *Models of human memory* (pp. 375–447). New York: Academic Press.
- Shiffrin, R. M. (1976). Capacity limitations in information processing, attention, and memory. In W. K. Estes (Ed.), *Handbook of learning and cognitive processes* (pp. 177–236). New York: Erlbaum.
- Shiffrin, R. M. (1993). Short-term memory: A brief commentary. *Memory & Cognition*, 21, 193–197.
- Shiffrin, R. M., & Atkinson, R. C. (1969). Storage and retrieval processes in long-term memory. *Psychological Review*, 79, 179–193.
- Shimamura, A. P. (1995). Memory and frontal lobe function. In M. S. Gazzaniga (Ed.), *The cognitive neurosciences* (pp. 803–813). Cambridge, MA: MIT Press.
- Shute, V. J. (1991). Who is likely to acquire programming skills? *Journal of Educational Computing Research*, 7, 1–24.
- Simons, J. S., & Spiers, H. J. (2003). Prefrontal and medial temporal lobe interactions in long-term memory. *Nature Reviews Neuroscience*, 4, 637–648.
- Smith, E. E., Geva, A., Jonides, J., Miller, A., Reuter-Lorenz, P. A., & Koeppel, R. A. (2001). The neural basis of task-switching in working memory: Effects of performance and aging. *Proceedings of the National Academy of Sciences*, 98, 2095–2100.
- Speer, N. K., Jacoby, L. L., & Braver, T. S. (2003). Strategy-dependent changes in memory: Effects on behavior and brain activity. *Cognitive, Affective, & Behavioral Neuroscience*, 3, 155–167.
- Sternberg, S. (1966, August). High-speed scanning in human memory. *Science*, 153, 652–654.
- Thompson-Schill, S. L., Jonides, J., Marshuetz, C., Smith, E. E., D'Esposito, M., Kan, I. P., et al. (2002). Effects of frontal lobe damage on interference effects in working memory. *Cognitive, Affective, & Behavioral Neuroscience*, 2, 109–120.
- Tirre, W. C., & Pena, C. M. (1992). Investigation of functional working memory in the reading span test. *Journal of Educational Psychology*, 84, 462–472.
- Tulving, E. (1983). *Elements of episodic memory*. New York: Oxford University Press.
- Tulving, E., & Colotla, V. A. (1970). Free recall of trilingual lists. *Cognitive Psychology*, 1, 86–98.
- Tulving, E., & Thomson, D. (1973). Encoding specificity and retrieval processes in episodic memory. *Psychological Review*, 80, 352–372.
- Turner, M. L., & Engle, R. W. (1989). Is working memory capacity task dependent? *Journal of Memory and Language*, 28, 127–154.
- Underwood, B. J. (1975). Individual differences as a crucible in theory construction. *American Psychologist*, 30, 128–134.
- Unsworth, N., & Engle, R. W. (2005). Working memory capacity and fluid abilities: Examining the correlation between operation span and raven. *Intelligence*, 33, 67–81.
- Unsworth, N., & Engle, R. W. (2006a). Simple and complex memory spans and their relation to fluid abilities: Evidence from list-length effects. *Journal of Memory and Language*, 54, 68–80.
- Unsworth, N., & Engle, R. W. (2006b). A temporal–contextual retrieval account of complex span: An analysis of errors. *Journal of Memory and Language*, 54, 346–362.
- Unsworth, N., & Engle, R. W. (in press). Individual differences in working memory capacity and retrieval: A cue-dependent search approach. In *The foundations of remembering: Essays in honor of Henry L. Roediger III*. New York: Psychology Press.
- Unsworth, N., Heitz, R. P., Schrock, J. C., & Engle, R. W. (2005). An automated version of the operation span task. *Behavior Research Methods*, 37, 498–505.
- Unsworth, N., Schrock, J. C., & Engle, R. W. (2004). Working memory capacity and the antisaccade task: Individual differences in voluntary saccade control. *Journal of Experimental Psychology: Learning, Memory, and Cognition*, 30, 1302–1321.
- Usher, M., & Cohen, J. D. (1999). Short term memory and selection processes in a frontal-lobe model. In D. Heinke, G. W. Humphreys, & A. Olson (Eds.), *Connectionist models in cognitive neuroscience* (pp. 78–91). New York: Springer-Verlag.
- Usher, M., Cohen, J. D., Haarmann, H., & Horn, D. (2001). Neural mechanisms for the magical number 4: Competitive interactions and nonlinear oscillation. *Behavioral and Brain Sciences*, 24, 151–152.

- Vorberg, D., & Ulrich, R. (1987). Random search with unequal search rates: Serial and parallel generalizations of McGill's model. *Journal of Mathematical Psychology, 31*, 1–23.
- Watkins, M. J. (1974). Concept and measurement of primary memory. *Psychological Bulletin, 81*, 695–711.
- Watkins, M. J. (1979). Engrams as cuegrams and forgetting as cue overload: A cueing approach to the structure of memory. In C. R. Puff (Ed.), *Memory organization and structure* (pp. 173–195). New York: Academic Press.
- Watkins, O. C., & Watkins, M. J. (1975). Buildup of proactive inhibition as a cue-overload effect. *Journal of Experimental Psychology: Human Learning and Memory, 104*, 442–452.
- Waugh, N., & Norman, D. (1965). Primary memory. *Psychological Review, 72*, 89–104.
- Wickens, D. D., Born, D. G., & Allen, C. K. (1963). Proactive inhibition and item similarity in short-term memory. *Journal of Verbal Learning and Verbal Behavior, 2*, 440–445.
- Wickens, D. D., Moody, M. J., & Dow, R. (1981). The nature and timing of the retrieval process and of interference effects. *Journal of Experimental Psychology: General, 110*, 1–20.
- Williams, E. J. (1959). The comparison of regression variables. *Journals of the Royal Statistical Society, 21*(Series B), 396–399.
- Wixted, J. T., & Rohrer, D. (1993). Proactive interference and the dynamics of free recall. *Journal of Experimental Psychology: Learning, Memory, and Cognition, 19*, 1024–1039.
- Wixted, J. T., & Rohrer, D. (1994). Analyzing the dynamics of free recall: An integrative review of the empirical literature. *Psychonomic Bulletin and Review, 1*, 89–106.
- Yonelinas, A. P. (2002). The nature of recollection and familiarity: A review of 30 years of research. *Journal of Memory and Language, 46*, 441–517.
- Young, C. W., & Supa, M. (1941). Mnemonic inhibition as a factor in the limitation of memory span. *American Journal of Psychology, 54*, 546–552.

Appendix

Methods and Results for the Immediate Free Recall Experiment With Individuals With High and Low Working Memory Capacity (WMC)

Method

Participant Screening for WMC

All participants were prescreened for WMC with an automated version of the operation span task (Turner & Engle, 1989; Unsworth, Heitz, Schrock, & Engle, 2005). This is a computer-administered version of operation span that has been shown to have both good reliability and validity (e.g., Unsworth et al., 2005). The task required participants to solve a series of math operations while trying to remember a set of unrelated letters (*B, F, H, J, L, M, Q, R, and X*). Participants were presented with a math operation that they were told to solve. After solving the operation, participants were presented with a letter for 800 ms. Immediately after the letter was presented the next operation was presented. Three trials of each list length (three through seven) were presented, with the order of list length varying randomly. At recall, letters from the current set were recalled in the correct order by clicking on the appropriate letters (see Unsworth et al., 2005, for more details). Participants performed three sets of practice (with a list length of two). The Ospan score was the sum of recalled words for all of the sets in which the entire set was recalled in the correct order. Scores could range from 0 to 75.

Participants and Design

Participants were 32 high-span and 27 low-span individuals, as determined by Ospan score. Those participants scoring in the upper quartile of the Ospan distribution were deemed high-span individuals, whereas those scoring in the lower quartile were considered low-span individuals. Note that the quartiles were based on 296 participants. Participants were recruited from the participant pool at Georgia Institute of Technology and from the Atlanta community through newspaper advertisements. All participants were between the ages of 18 and 35 and received either

course credit or monetary compensation for their participation. Each participant was tested individually in a laboratory session lasting approximately 1 hr. Participants completed 2 practice lists with letters and 15 lists with words with 12 words per list.

Procedure

Participants were tested one at a time in the presence of an experimenter. Items were presented alone for 1 s each. At recall participants saw three question marks appear in the middle of the screen and heard a tone indicating that the recall period had begun. Participants were given 30 s to recall as many of the words as possible in any order they wished. For each spoken response (both correct and incorrect responses), an experimenter pressed a key indicating when in the recall period the response was given (e.g., Rohrer, 2002). After the 30 s of recall, participants again heard a tone indicating that the recall period was over. The experimenter then pressed a key to start the next trial.

Results

Participants

Data for 6 high- and 4 low-span participants were excluded from data analyses because of data collection problems. The mean Ospan scores for the final 26 high- and 23 low-span participants were 59.58 ($SD = 7.40$, range = 51–75) and 18.87 ($SD = 7.73$, range = 0–28), respectively. The mean ages for the high- and low-span participants were 22.68 ($SD = 4.43$) and 25.26 ($SD = 5.33$), respectively.

Serial Position Effects and Probability of First Recall

Observations of differences from the serial position curves were supported by a 2 (WMC group) \times 12 (serial position) mixed analysis of variance (ANOVA), with serial position as the within-

subjects variable. The ANOVA demonstrated strong serial position effects, $F(11, 517) = 156.96$, $MSE = 0.018$, $p < .01$, $\eta_p^2 = .77$. In addition, the results suggest that high WMC individuals had a higher probability of correct recall than low WMC individuals, $F(1, 47) = 31.34$, $MSE = 0.061$, $p < .01$, $\eta_p^2 = .40$. Furthermore, these two variables interacted suggesting that the high WMC individuals' advantage was greater for precency items than for recency items, $F(11, 517) = 2.30$, $MSE = 0.018$, $p < .01$, $\eta_p^2 = .05$.

Observations of differences in the probability of first recall (PFR) functions were supported by a 2 (WMC group) \times 12 (serial position) mixed ANOVA, with serial position as the within-subjects variable. The ANOVA yielded a strong advantage for recency items in terms of PFR, $F(11, 517) = 96.68$, $MSE = 0.014$, $p < .01$, $\eta_p^2 = .67$, as well as a significant two-way interaction with WMC group, $F(11, 517) = 11.18$, $MSE = 0.014$, $p < .01$, $\eta_p^2 = .19$. Note that there could not be a significant main effect of WMC group because the mean PFR for both groups had to be equal. The interaction suggested that high and low WMC individuals had similar PFRs for the first few serial positions but then differences began to emerge. Specifically, high WMC individuals had PFRs greater than zero for Serial Positions 5–12 (all $ps < .05$), whereas low WMC individuals had PFRs greater than zero only for the last three serial positions (all $ps < .05$).

Estimates of Primary and Secondary Memory

Observations of differences in estimates of PM and SM were supported by a 2 (WMC group) \times 2 (type of estimate: PM vs. SM) mixed ANOVA, with type of estimates as the within-subjects variable. The ANOVA yielded an effect of type of estimate, with more items being recalled from PM than SM ($M = 3.42$, $SE = 0.06$ vs. $M = 2.53$, $SE = 0.11$), $F(1, 47) = 53.74$, $MSE = 0.36$, $p < .01$, $\eta_p^2 = .53$. There was also a main effect of WMC group, $F(1, 47) = 32.46$, $MSE = 0.37$, $p < .01$, $\eta_p^2 = .41$, which is the same effect as seen previously in the probability of correct recall analyses. Furthermore, the two-way interaction of these variables approached conventional levels of significance, $F(1, 47) = 3.50$, $MSE = 0.36$, $p = .068$, $\eta_p^2 = .07$. Note, however, that this interaction replicates previous research by Engle et al. (1999). We reanalyzed their data, examining only high- ($n = 46$) and low-span individuals ($n = 47$) on the basis of the operation span task and found similar results (see Table 1). Specifically, high WMC individuals recalled more items from both PM and SM than did low WMC individuals, $F(1, 91) = 33.64$, $MSE = 0.40$, $p < .01$, $\eta_p^2 = .27$. However, the WMC difference was larger for SM items than for PM items, $F(1, 91) = 12.33$, $MSE = 0.40$, $p < .01$, $\eta_p^2 = .12$.

A 2 (WMC group) \times 2 (type of estimate: PM vs. SM) \times 4 (list) mixed ANOVA with type of estimate and list as the within-subjects variables supported the conclusions of differences between PM and SM estimates as a function of list. More items were retrieved from PM than SM ($M = 3.40$, $SE = 0.08$ vs. $M = 2.38$, $SE = 0.10$), $F(1, 141) = 63.47$, $MSE = 1.50$, $p < .01$, $\eta_p^2 = .58$. The number of items recalled tended to decrease from List 1 to List 4, $F(3, 141) = 3.13$, $MSE = 1.50$, $p < .05$, $\eta_p^2 = .06$. These two

variables interacted such that the number of items recalled from PM remained fairly constant across lists, but the number of items recalled from SM decreased across lists, $F(3, 141) = 7.59$, $MSE = 1.50$, $p < .01$, $\eta_p^2 = .14$. This effect did not interact with WMC group ($F < 1$).

Recall Errors

Conclusions concerning individual differences in WMC and errors were supported by three separate independent samples t tests. The results suggested that high and low WMC individuals differed only in previous list intrusions, with low WMC individuals making more previous list intrusions than high WMC individuals, $t(47) = 2.14$, $p < .05$, $\eta^2 = .09$. High and low WMC individuals did not differ in extralist intrusions, $t(47) = 0.85$, $p > .39$, $\eta^2 = .02$, or in repetitions, $t(47) = 1.19$, $p > .23$, $\eta^2 = .03$.

Response Latency

Observations of differences in the parameter estimates and mean response latency were supported by several independent samples t tests. For the parameter estimates, high WMC individuals had larger values of both N and λ than low WMC individuals (both $ps < .05$, one-tailed). For mean response latency for all responses, high WMC individuals had shorter response latencies than low WMC individuals, $t(47) = 2.14$, $p < .05$, $\eta^2 = .09$.

Observations of differences in response latency growth functions for the first six responses were supported by a 2 (WMC group) \times 6 (response) mixed ANOVA, with response as the within-subjects variable. The ANOVA (of course) yielded a main effect of response, $F(5, 235) = 431.59$, $MSE = 1,843,562.92$, $p < .01$, $\eta_p^2 = .90$. There was also a main effect of WMC group, in which high WMC individuals had shorter response latencies than low WMC individuals ($M = 4.19$ s, $SE = 0.29$ vs. $M = 6.14$ s, $SE = 0.31$), $F(1, 47) = 21.36$, $MSE = 13,114,433.55$, $p < .01$, $\eta_p^2 = .31$. Furthermore, these two variables interacted, $F(5, 235) = 18.21$, $MSE = 1,843,562.92$, $p < .01$, $\eta_p^2 = .28$.

Interresponse Times (IRTs)

A 2 (WMC group) \times 5 (IRT interval) mixed ANOVA, with IRT interval as the within-subjects variable, supported the conclusions concerning differences in IRTs. There was a main effect of IRT interval, $F(4, 188) = 81.98$, $MSE = 1,044,038.97$, $p < .01$, $\eta_p^2 = .64$. There was a main effect of WMC group, suggesting that high WMC individuals had faster IRTs than low WMC individuals ($M = 1.64$ s, $SE = 0.14$ vs. $M = 2.65$ s, $SE = 0.15$), $F(1, 47) = 23.91$, $MSE = 2,595,754.62$, $p < .01$, $\eta_p^2 = .34$. The two variables also interacted, suggesting that there were small differences for the first few IRTs, but that the difference between the WMC groups increased as IRT interval increased, $F(4, 188) = 6.33$, $MSE = 1,044,038.97$, $p < .01$, $\eta_p^2 = .12$.

Received October 28, 2005

Revision received August 21, 2006

Accepted August 22, 2006 ■